



CATALOG 2024

EXQUISITE DRAPERY HARDWARE FROM
A SOURCE WITH 40+ YEARS OF EXPERIENCE



THE VESTA DIFFERENCE

VISION STATEMENT

Vesta strives to provide our customers with a knowledgeable and courteous sales staff, prompt delivery, competitive pricing, and extensive product offerings that feature the most up-to-date decorative drapery hardware from around the world. Satisfying the customers' needs is our top priority. We value our relationships with our employees, customers, vendors, and suppliers. Our employees are the most valuable resource at Vesta. Together we will embark on the future while remembering the lessons that have brought us to where we are today.

MISSION STATEMENT

Our mission at Vesta is to provide our clients with a compelling customer experience through a selection of drapery hardware to achieve their design ambitions.



Bret (General Manager) and Nick Jackson (Operations Manager)



OVERVIEW

COLLECTIONS

TRADITIONAL	5-29	CORD CONTROL	67-73
BLACKSMITH	6-7	TECHNO TOPIA	68-69
BRISE BISE	8-9	PURTEC CORD	70-71
CASTILIAN	10-11	DECO [R] CORD	72
EUROPEAN ELEGANCE	12-13	HUNLEY CORD	73
HELENA	14-15		
HIGHLAND TIMBER	16-19	MOTOR CONTROL	75-79
HUNLEY	20-23	MOTOPIA	76-77
MEDITERRANEAN	24-25	PURTEC MOTOR	78-79
OPERA	26-27		
ROYAL BRITANNICA	28-29		
		CREDITS	
MODERN	31-43	Cover + Page 45	
APOLLO	32-33	Pure Design- Designer	
CRYSTALENE	34-35	Daniel Newcomb- Photography	
GEOLUX MANUAL	36-39	Page 5 + 26	
LE MANS MANUAL	40-41	Sarah Ponden Interiors /	
MISTRAL	42-43	Abby Cole Photography	
		Page 24	
TRACK SYSTEMS	45-65	Traditions of Charlotte	
DECO [R]	46-47	Page 32	
DECO TRAX	48-49	Sarah Catherine Select	
NOVI	50-51	Page 42 + 43	
ECO-DECO	52-53	Maggie Getz Studio- Designer	
GEOLUX TRACK	54-57	Aimee Mazzenga- Photo	
LE MANS TRACK	58-59	Page 52	
PURTEC MANUAL	60-61	Parkcity Blind and Design-Designer	
TECHNO TRACK	62-63	Josh Caldwell- Photography	
TITAN TRACK	64-65	Page 62	
		Sarah Ponden Interiors /	
		Abby Cole Photography	

TRADITIONAL

COLLECTION



Copyright by Sarah Ponden Interiors / Abby Cole Photography





TRADITIONAL

BLACKSMITH

COLLECTION

Experience the raw beauty of hand-forged iron hardware. Vesta discovered a talented local artisan skilled in the Old World art of blacksmithing. Each piece is meticulously hand-forged and tempered by fire in three rustic finishes. Unique to this collection is a solid 1" diameter hammered rod.



BL

B

NA

AVAILABLE FINISHES:

- BL = black
- B = bronze
- NA = natural (iron)

FINIALS

- | | | |
|---------------------------------------------------|------------------------------------------------------|--------------------------------------------------------|
| A. Zug #251070
2"W, 2.5/8"L
*shown in NA | D. Constance #251060
1.5/8"W, 6"L
*shown in NA | G. Geneva #251050
3"W, 7"L
*shown in NA |
| B. Pergola #251010
6½"W, 7"L
*shown in B | E. Ticino #251040
3"W, 7"L
*shown in BL | H. Tuscany #251030
5.1/2"W, 7"L
*shown in B |
| C. Sundern #251080
3.1/4"W, 4"L
*shown in B | F. Valais #251020
4"W
*shown in NA | I. End Cap #251005
1.1/2"W, 1.1/8"L
*shown in BL |

SPECIAL ORDER
3-4 weeks, no returns



AVAILABILITY:
special order 3-4 weeks,
no returns

PRIMARY MATERIALS:
wrought iron

DIAMETER & BRACKET
REQUIREMENTS:
1"D: bracket required
every 6-7 feet

BRACKETS & ACCESSORIES

	Bienne wall bracket (short) #252503 - 3"W, 4.3/8"L, 3.1/2"P *shown in B		Hammered holdback #907510 - 3"D, 2.1/2"P, 3"W *shown in NA	
	Bienne wall bracket (long) #252506 - 3"W, 4.3/8"L, 6"P *shown in BL		Spiral holdback #907520 - 3"D, 2.1/2"P, 3"W *shown in NA	
	Lugano wall bracket (short) #252403 - 1.1/2"W, 4"L, 3.1/2"P *shown in BL		Hammered Rod (solid) #259000 - 1"D *max length 10 feet	Smooth Ring w/eye #256000 1.1/2"ID, 1.15/16"OD *shown in BL
	Lugano wall bracket (long) #252406 - 1.1/2"W, 4"L, 6"P *shown in B		Iron Tubing (Hollow) #258000 - 1"D *max length 10 feet	
	Scroll wall bracket #252603 - 3.1/2"P, 4.3/8"L, 3"W *shown in NA		Tube Splice #258090 *For 258000	
	Inside Mount #255000 - 2.7/8"W, 1/3/8"L *shown in NA		French return #259090 - 1"D *shown in BL	Twisted Ring w/eye #256010 1.1/2"ID, 1.15/16"OD *shown in NA

SHIPPING & ADDITIONAL NOTES:

Due to the nature of hand-forging slight variances in dimensional characteristics are to be expected. The solid hammered rod is heavy. Brackets MUST BE stud mounted. Improper installation may cause injury. The curtain rings in this collection are not hand-forged.

TRADITIONAL



BRISE BISE

COLLECTION

Taken from the French meaning “a light breeze”, Vesta’s BRISE BISE Collection features solid brass hardware designed for café style, light-weight treatments. All items are in-stock for quick shipping



AB BL PB PN

AVAILABLE FINISHES:

- AB = antique brass
- PB = polished brass
- PN = polished nickel
- BL = black

FINIALS

Regency
#161020 - 1.1/4"W, 1"L



Ball
#161070 - 1.1/8"W, 1.1/2"L



End Cap
#161001 - 3/4"W, 1/2"L



Handel
#161016 - 3/4"W, 1.3/8"L

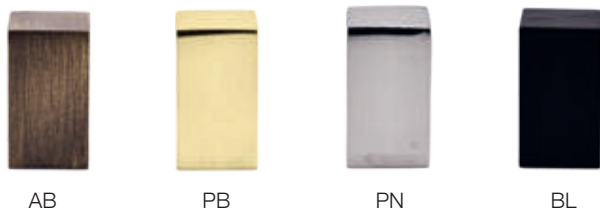

AVAILABILITY:
in-stock, typically ships
within 24-48 hours

PRIMARY MATERIALS:
■ brass

DIAMETER & BRACKET
REQUIREMENTS:
5/8"D: bracket required
every 4-5 feet



BRACKETS



Wall Bracket
#162060
1.1/4"W, 2.1/4"P
*shown in PB



Inside Mount
#162001
7/8"W, 3/8"L
*shown in PB



Sash Bracket
#162070
5/8"W, 3/4"P
*shown in PB



Wall Bracket (long)
#162090
1"W, 4.3/8"P
*shown in AB

RINGS



Ring w/eye
#166031
15/16"ID, 1.3/16"OD
*shown in PB



Ring hollow w/clip
#166030
1"ID, 1.3/8"OD
*shown in PB

TUBING

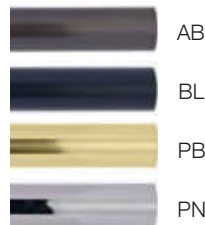

Brass Tubing
#168000
5/8"D

*will cut to your
specifications



Tube Splice
#168090V
5/8"W, 4.3/4"L

SHIPPING & ADDITIONAL NOTES:

Splicing when applicable can significantly reduce freight charges. We can help you make the best informed decision when it's time to ship your order.

TRADITIONAL



CASTILIAN

COLLECTION

Vesta's CASTILIAN Collection features solid brass hardware designed to complement any traditional design setting. Experience the look and feel of solid brass décor. All items are in-stock for quick shipping.



PB

AVAILABLE FINISHES:

PB = polished brass
(ornate brass accentuated)

FINIALS

- A. Barcelona #351070 2.1/2"W, 3.3/4"L
- B. Malaga #351050 2.1/4"W, 3"L
- C. Sevilla #351020 2.1/4"W, 2"L
- D. Cordoba #351100 2.1/2"W, 4"L (ornate brass accentuated)
- E. End Cap #351240 1.9/16"W, 7/8"L



AVAILABILITY:
stock, typically ships
within 24-48 hours

PRIMARY MATERIALS:
■ brass ■ acrylic

DIAMETER & BRACKET
REQUIREMENTS:
1 3/8"D: bracket required
every 6-7 feet brass,
4-5 feet acrylic

BRACKETS



Madrid wall bracket
#352062 - 2.3/8"W, 2.3/8"P
#352066 - 2.3/8"W, 6"P



Barcelona
double wall bracket
#352070 - 2"W, 3.1/4"
& 6.1/8"P



Inside Mount
#352221 - 2.9/16"W, 1"L



Leon
Plain Bracket
#352160 - 2.1/4"W, 8"P



Wand
#910100 - 39"L
#910125 - 49"L
#910150 - 59"L

LOOPS



#907610 - 13.1/2"L, 6"P



#907620 - 13.1/2"L, 6"P (ornate brass accentuated)

ACCESSORIES



Brass Clip
#909110



Tube Splice
#358090 - 1.3/8"D, 6"L



Brass Tubing plain
#358000 - 1.3/8"D
* Sold by the foot. Will cut
to your specifications.



Brass Tubing reeded
#358020 - 1.3/8"D
* Sold by the foot. Will cut
to your specifications.



Acrylic Pole
#351800 - 1.3/8"D, 71"L

Acrylic Pole
#352400 - 1.3/8"D, 94"L

RINGS



Hollow Ring w/clip
#356030
2"ID, 2.3/4"OD



Solid Ring w/eye
#356012
1.3/4"ID, 2.1/4"OD



Cuffed Ring w/clip
#356020
2.1/4"ID, 2.3/4"OD

SHIPPING & ADDITIONAL NOTES:

Splicing when applicable can significantly reduce freight charges. We can help you make the best-informed decision when it's time to ship your order.

TRADITIONAL



EUROPEAN ELEGANCE

COLLECTION

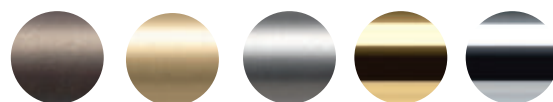

ABM BB BN PB PC

Vesta's EUROPEAN ELEGANCE Collection features an ensemble of meticulously crafted accessories perfect for any contemporary or traditional setting. This decorative compilation is available in several popular finishes.

AVAILABLE FINISHES:

- ABM = antique brass matte
- BB = brushed brass
- BN = brushed nickel
- PB = polished brass
- PC = polished chrome

FINIALS & SAMPLE SETS

Selva finial ▼ #281647
1.5/8"W, 3.7/16"L



Dome finial ▼ #281665
2.7/16"W, 2.3/4"L



Roller finial ▼ #281680
1.3/4"W, 2.3/8"L



Pescara finial ▼ #281690
1.3/8"W, 5.3/16"L



Arcadia finial ▼ #281362
2.3/8"W, 3.5/8"L



Bella finial ▼ #281389
2.3/8"W, 3.1/2"L



AVAILABILITY:
special order 3-4 weeks,
no returns

PRIMARY MATERIALS:
■ brass

DIAMETER & BRACKET
REQUIREMENTS:
▼ 1 1/8"D: bracket
required every 5-7 feet

BRACKETS & ACCESSORIES

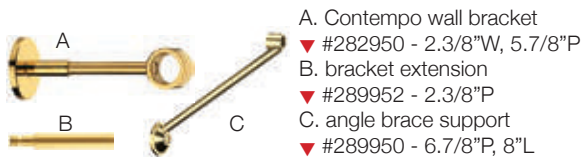

A. Contempo wall bracket
▼ #282950 - 2.3/8"W, 5.7/8"P
B. bracket extension
▼ #289952 - 2.3/8"P
C. angle brace support
▼ #289950 - 6.7/8"P, 8"L

*may be used as a ceiling bracket unless stem has been cut to create a custom projection

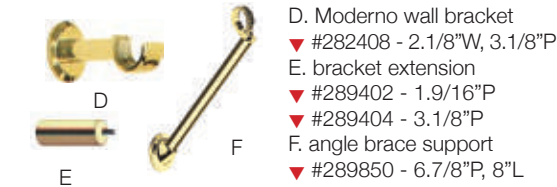

D. Moderno wall bracket
▼ #282408 - 2.1/8"W, 3.1/8"P
E. bracket extension
▼ #289402 - 1.9/16"P
▼ #289404 - 3.1/8"P
F. angle brace support
▼ #289850 - 6.7/8"P, 8"L

TUBING

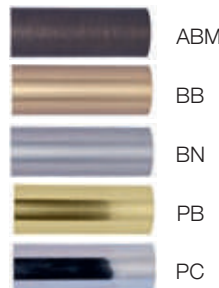











Brass Tubing
▼ #288000 - 1.1/8"D
*sold by the foot but may be cut
to specified lengths, no charge



Incurve elbow bracket
w/return eyelets
▼ #289080
1.7/8"W, 3.1/8"P



Incurve elbow bracket
w/return eyelets
▼ #289120
1.7/8"W, 4.3/4"P

 <p>Moderno double wall bracket ▼ #282428 2.1/8"W, 3.1/8" & 6.1/4"P</p>	 <p>Classico inside mount ▼ #282220 1.1/4"W, 1.1/16"L</p>	 <p>Ring w/clip ▼ #286125 1.3/8"ID, 1.3/4"OD</p>	 <p>Ring w/eye & insert ▼ #286127 1.1/2"ID, 2"OD</p>	 <p>Flat Ring w/eye & insert ▼ #285930 1.1/2"ID, 1.7/8"OD</p>
 <p>Mazzi ceiling mount #902228 1.1/4"W, 1.1/8"P</p>	 <p>Tube Splice ▼ #298181 1.1/8"D, 4.3/4"L</p>	 <p>Tube Connector ▼ #289229 1.1/8"D, 3.1/8"L *adjusts 90° to 180°</p>	 <p>End Cap ▼ #281240 1.1/4"W, 3/4"L</p>	 <p>Flush End Cap ▼ #281241 1.1/8"W, 7/16"L</p>

WANDS



Wand
#912100 - 39"L
912125- 49"L



Acrylic Wand
#968100 - 39"L

SHIPPING & ADDITIONAL NOTES:

Splicing when applicable can significantly reduce freight charges. We can help you make the best-informed decision when it's time to ship your order.

TRADITIONAL



HELENA

COLLECTION

Vesta's HELENA Collection features the strength of steel in four popular finishes. Bold and elegant designs are offered to solve various design challenges. All items are in-stock for quick shipping and available at an attractive price point.



AB BN ORB PC

AVAILABLE FINISHES:

- AB = antique brass
- BN = brushed nickel
- ORB = oil-rubbed bronze
- PC = polished chrome

FINIALS

- A. Paris #501041
4"W, 5.7/8"L
*shown in PC
- B. Troy #501048
3.3/4"W, 4.7/8"L
*shown in AB
- C. Sparta #501097
3.1/4"W, 5.3/4"L
*shown in BN
- D. Agamemnon #501006
3.1/2"W, 4.3/4"L
*shown in PC
- E. Priam #501006
2.1/4"W, 4.3/4"L
*shown in BN
- F. Menelaus #501021
3.3/4"W, 6"L
*shown in ORB



A



B



C



D



E



F

AVAILABILITY:
in-stock, typically ships
within 24-48 hours

PRIMARY MATERIALS:
■ steel

DIAMETER & BRACKET
REQUIREMENTS:
2"D: bracket required
every 6-8 feet

BRACKETS & ACCESSORIES



Athens short
#502113
*shown in ORB
2.1/2"W, 3.1/8"P



Athens medium
#502116
*shown in ORB
2.1/2"W, 4.3/4"P



Trojan drop-in #502106
*shown in ORB
2.15/16"W, 4.1/4"-9.1/4"P
*stem can be cut to adjust the
projection, range is shown in the
dimensions above



Econo drop-in #502103
*shown in AB
1.1/8"W, 4.1/2"-5.1/2"P
*projection can be adjusted,
the range is shown in the dimensions
above



Inside Mount
502101
*shown in ORB
2.3/4"W, 2.1/8"L



End Cap
#501001
*shown in AB
2.1/4"W, 1.5/16"L



Ring w/eye & insert
#506110 *shown in ORB
2.1/2"ID, 3"OD



Elbow Tube Connector
#509229
*adjusts 90° to 180°
2"D



Tube Splice
#508191
2"D, 8"L



Acrylic Pole
#501800 - 2"D, 71"L
#502400 - 2"D, 94"L

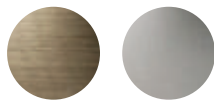

AB BN

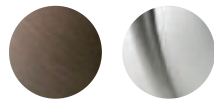

ORB PC

Steel Tubing
#508004 - 2"D, 4'L
#508006 - 2"D, 6'L
#508008 - 2"D, 8'L

*will cut to your specified length no charge



Wand
#900010 - 39"L
#900025 - 49"L
#900050 - 59"L
*shown in ORB

SHIPPING & ADDITIONAL NOTES:

Due to changes in the shipping industry, rods at 96" are billed at the 90lb. ground rate. The collection's rod splice can be used to achieve longer spans. In some applications the center bracket will conceal the splice point.



TRADITIONAL

HIGHLAND TIMBER

COLLECTION

Vesta's HIGHLAND TIMBER Collection features a gallery of masterfully carved finials and accessories. This line offers two pole diameters and ranges from understated and simple to intrinsically elegant designs. All components are made available unfinished and stain-grade to become the blank canvas or your own unique interpretations.



UF

AVAILABLE FINISHES:

UF = unfinished

WOOD POLES

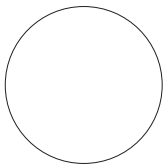

Plain Wood Pole
Sold in 4' / 6' / 8' / 12' lengths
(will cut to your specified lengths, no charge)
✦ #348100 - 1.3/8"D
✦ #578100 - 2.1/4"D



Reeded Wood Pole
Sold in 4' / 6' / 8' / 12' lengths
(will cut to your specified lengths, no charge)
✦ #348120 - 1.3/8"D
✦ #578120 - 2.1/4"D

AVAILABILITY:
in-stock, typically ships
within 24-48 hours

PRIMARY MATERIALS:
■ wood

DIAMETER & BRACKET
REQUIREMENTS:

✦ 1 3/8" D: bracket
required every 4-5 feet

✦ 2 1/4" D: bracket
required every 6-8 feet

✦ color/shape indicates compatibility
with 1 3/8" diameter poles
✦ color/shape indicates compatibility
with 2 1/4" diameter poles

ACCESSORIES

Shield Tieback
#905231 - 3.3/4"W, 4"P
#905232 - 2.3/4"W, 4"P



Ombra Tieback
#905230 - 4.1/2"W, 6"P



End Cap
✦ #341100 - 1.3/4"W, 1.1/4"L
✦ #571100 - 2.1/2"W, 1.1/4"L



Pole Splice
#909200 - 2"L



BRACKETS



Ebro short
✦ #342710
2.1/2"W, 1.3/4"P



Tagus medium
✦ #342770
3.3/8"H, 1.1/4"W, 3.3/8"P
✦ #572770
6"H, 1.1/4"W, 5.1/2"P



Ebro medium
✦ #342730
2.1/2"W, 3.1/2"P



Tagus long
✦ #342790
3.1/4"H, 1.1/4"W, 4.3/4"P
✦ #572790
6"H, 1.1/4"W, 8"P



Ebro long
✦ #342750
2.1/2"W, 7"P
*stem may be cut



Inside Mount
✦ #342000
2.1/2"W, 3/4"P
✦ #572000
3.1/8"W, 1.1/4"P



Ebro double
✦ #342760
2.1/2"W, 2.3/4"P, 5.1/2"P



Wand
#900100 - 39"L
#900125 - 49"L
#900150 - 59"L



Ebro medium
✦ #572730
3"W, 3.3/4"P



A. Reeded Ring w/eye
✦ #346120 - 2.1/4"ID, 3"OD
✦ #576120 - 3"ID, 4"OD



Ebro long
✦ #572750
3"W, 5.3/8"P

B. Plain Ring w/eye
✦ #346100 - 1.5/8"ID, 2.1/2"OD
✦ #576100 - 3"ID, 4"OD

SHIPPING & ADDITIONAL NOTES:

Splicing when applicable can significantly reduce freight charges. We can help you make the best-informed decision when it's time to ship your order.

FINIALS

for 1 $\frac{3}{8}$ "D

◆ color/shape indicates compatibility with 1 $\frac{3}{8}$ " diameter poles



Ysabena
◆ #341250
2.1/4"W, 4.3/4"L



Ebro
◆ #341290
2.1/4"W, 4"L



Fluvia
◆ #341280
2.1/4"W, 4.3/4"L



Naches
◆ #341300
2.1/8"W, 3.1/2"L



Cinca
◆ #341240
2.1/4"W, 4"L



Aragon
◆ #341230
2.1/4"W, 4.3/4"L



Yakima
◆ #341270
2"W, 4.1/2"L



Williamette
◆ #341360
2"W, 2"L

TRADITIONAL



FINIALS

for 2¼"D

* color/shape indicates compatibility with 2¼"D poles



Ysabena
* #571340
2.3/4"W, 5.1/2"L



Saragossa
* #571350
3"W, 5.1/2"L



Willamette
* #571360
2.3/4"W, 3.3/8"L



Pamplona
* #571370
3"W, 4"L



Aberdeen
* #571150
3.1/8"W, 5"L



Yakima
* #571270
2.7/8"W, 6.3/8"L



Naches
* #571300
2.7/8"W, 4.1/2"L



Andorra
* #571310
3"W, 4.1/2"L



Gerona
* #571320
3"W, 6"L



Newcastle
* #571180
4.5/8"W, 5.1/4"L



Vitoria
* #571330
3"W, 5"L



Navarro
* #571470
3"W, 5.1/2"L



San Sebastian
* #571480
3"W, 6"L



Stirling
* #571190
3.1/2"W, 4.7/8"L



Edinburgh
* #571160
4.3/8"W, 5.1/2"L



TRADITIONAL

HUNLEY

COLLECTION

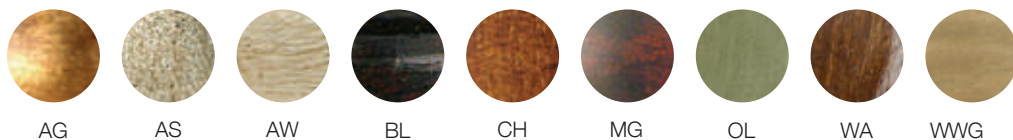

Vesta's HUNLEY collection showcases hand-sculpted and hand-finished traditional finish designs by one of the United States' most accomplished artisans. The beauty resides in the details of each masterpiece. Items are available in a rich palette of colors or finish combinations creating the zenith of extravagance.

AVAILABLE FINISHES:

- AG-B = antique gold, black base coat
- AG-R = antique gold, rust base coat
- AS-R = antique silver, rust base coat
- AS-B = antique silver, black base coat
- AW = antique white
- AW-C = antique white / crackled
- BL = antique black
- BL-C = antique black / crackled
- CH = chestnut
- MG = mahogany
- OL = olive
- OL-C = olive / crackled
- WA = walnut
- WWG = white wash gold

RESIN FINIALS

- | | | |
|---------------------------------------------------------------------------------------------------------------------------------------------------------------------------------------------------------------------------------------------------------------------------------------------------------------------------------------------------|-----------------------------------------------------------------------------------------------------------------------------------------------------------------------------------------------------------------------------------------------------------------------------------------------------------------------------------------------------|----------------------------------------------------------------------------------------------------------------------------------------------------------------------------------------------------------------------------------------------------------------------------------------------------------------------------------------------------------|
| <p>A. Mallory
 #351120 - 2.3/4"W, 4.3/4"L
 *shown in AG-R, CH Combo</p> <p>B. Johnstone
 #351180 - 1.7/8"W, 1.1/2"L
 *shown in AS-B, AW Combo</p> <p>C. Murphey
 #351150 - 1.3/4"W, 2.3/4"L
 *shown in AS-B, BL Combo</p> | <p>D. Fraser
 #351130 - 2.1/8"W, 4.1/4"L
 *shown in AS-R, AG-R Combo</p> <p>E. Halligan
 #351140 - 2.3/4"W, 4.3/4"L
 *shown in AS-R, WA Combo</p> <p>F. Slaughter
 #351190 - 1.3/4"W, 1.3/4"L
 *shown in AS-R, CH Combo</p> | <p>G. Maury
 #351170 - 1.3/4"W, 2.3/4"L
 shown in AS-R, OL Cracked</p> <p>H. Nicholson whittled
 #351160 - 1.3/4"W, 2.3/4"L
 *shown in AG-R, WA Combo</p> <p>I. Semmes
 #351195 - 2.3/8"W, 2.5/8"L
 *shown in AG-R, OL Combo</p> |
|---------------------------------------------------------------------------------------------------------------------------------------------------------------------------------------------------------------------------------------------------------------------------------------------------------------------------------------------------|-----------------------------------------------------------------------------------------------------------------------------------------------------------------------------------------------------------------------------------------------------------------------------------------------------------------------------------------------------|----------------------------------------------------------------------------------------------------------------------------------------------------------------------------------------------------------------------------------------------------------------------------------------------------------------------------------------------------------|



A B C D E F G H I

AVAILABILITY:
 special order 3-4 weeks,
 no returns

PRIMARY MATERIALS:
 resin, wood

DIAMETER & BRACKET
 REQUIREMENTS:

- 1 3/8" D: bracket
 required every 4-5 feet
 - 2" D: bracket
 required every 5-6 feet
 - 2 1/4" D: bracket
 required every 6-8 feet
- * Benjamin Moore Paint
 available - \$30 upcharge

WOOD POLES

sold by the foot - will cut to your specified lengths, no charge



- Plain
- #358100 - 1.3/8"D
 - #508100 - 2"D
 - #588100 - 2.1/4"D
- Reeded
- #358120 - 1.3/8"D
 - #508120 - 2"D
 - #588120 - 2.1/4"D
- Whittled
- #358130 - 1.3/8"D
 - #508130 - 2"D
 - #588130 - 2.1/4"D
- Bamboo
- #358140 - 1.3/8"D
 - #508140 - 2"D
 - #588140 - 2.1/4"D



- Elbow Connector
- #359090 - 1.3/8"D, 2.1/2"L
 - #509090 - 2"D, 3"L
 - #589090 - 2.1/4"D, 3.3/4"L
- *adjusts 90° to 180°

- Pole Splice
 #909200 - 2"L



- color/shape indicates compatibility with 1 3/8" diameter poles
- color/shape indicates compatibility with 2" diameter poles
- color/shape indicates compatibility with 2 1/4" diameter poles

Combinations are available for most finials since items are custom made to order. Areas of solid color lacking intricate detail may have their finish cracked for an additional charge. Available finishes are: antique gold/black base coat (AG-B), antique gold / rust base coat (AG-R), antique silver / black base coat (AS-B), antique silver / rust base coat (AS-R), antique white (AW), antique white / cracked (AW-C), antique black (BL), chestnut (CH), antique black / cracked (BL-C), mahogany (MG), olive (OL), olive / cracked (OL-C), walnut (WA), white wash gold (WWG)

SHIPPING & ADDITIONAL NOTES:

Splicing when applicable can significantly reduce freight charges. We can help you make the best informed decision when it's time to ship your order.

RESIN FINIALS



A B C D E F G H I



J K L M N O P Q R

- A. Carlson
 ♦ #581103 - 3"W, 6.1/4"L
 *shown in AG-R, MG Combo
- B. Simkins
 ♦ #581105 - 3.3/4"W, 6.1/4"L
 *shown in AG-R, MG Combo
- C. Ridgeway
 ♦ #581107 - 3"W, 5"L
 *shown in WWG
- D. Wicks
 ♦ #581108 - 2.3/4"W, 5.1/2"L
 *shown in AG-R, MG Combo
- E. White
 ♦ #581109 - 3"W, 5"L
 *shown in AG-R
- F. Collins
 ♦ #581110 - 3"W, 4.3/4"L
 *shown in AG-R, BL Combo
- G. Hunley
 ♦ #581101 - 3.3/4"W, 6.1/8"L
 *shown in AG-R, BL Combo
- H. Robinson
 ♦ #581131 - 4.1/2"W, 7.1/2"L
 *shown in AG-R, OL Combo
- I. Marshall
 ♦ #581135 - 3.1/2"W, 3.1/2"L
 *shown in AG-R, MG Combo
- J. Miller
 ♦ #581112 - 3"W, 2"L
 *shown in AG-R
- K. Kelly
 ♦ #581125 - 3.1/2"W, 5"L
 *shown in WWG, AW-C Combo
- L. Singer
 ♦ #581122 - 4"W, 6.1/2"L
 *shown in AG-R, MG Combo
- M. McClintock
 ♦ #581124 - 3.1/2"W, 5"L
 *shown in AG-B
- N. Davis
 ♦ #581126 - 3"W, 4.3/4"L
 *shown in AG-R
- O. Kane
 ♦ #581127 - 6"W, 6"L
 *shown in AG-R
- P. Beard
 ♦ #581134 - 5"W, 5"L
 *shown in AG-R



- Q. Ellis
 ♦ #581136 - 3"W, 2.3/16"L
 *shown in WA
- R. Lawson
 ♦ #581137 - 3.1/8"W, 3.1/2"L
 *shown in AS-R, AW Combo
- S. Beaugard
 ♦ #501113 - 2.5/8"W, 2"L
 *shown in AG-R
- T. Alexander
 ♦ #501106 - 2.5/8"W, 5.3/4"L
 *shown in AG-R

TRADITIONAL

- ♦ color/shape indicates compatibility with 1 3/8" diameter poles
- ♦ color/shape indicates compatibility with 2" diameter poles
- ♦ color/shape indicates compatibility with 2 1/4" diameter poles

Combinations are available for most finials since items are custom made to order. Areas of solid color lacking intricate detail may have their finish crackedled for an additional charge. Available finishes are: antique gold/black base coat (AG-B), antique gold / rust base coat (AG-R), antique silver / black base coat (AS-B), antique silver / rust base coat (AS-R), antique white (AW), antique white / crackedled (AW-C), antique black (BL), chestnut (CH), antique black / crackedled (BL-C), mahogany (MG), olive (OL), olive / crackedled (OL-C), walnut (WA), white wash gold (WWG)

BRACKETS & ACCESSORIES



Sumter short
 ▶ #352013 - 2.1/8"W, 3.1/2"P
 ✚ #502013 - 2.7/8"W, 4"P
 ◆ #582013 - 3.1/4"W, 4.1/4"P
 *shown in AG-R



Sumter long
 ▶ #352016 - 2.3/8"W, 5.1/4"P
 ✚ #502016 - 2.7/8"W, 5.1/2"P
 ◆ #582016 - 3.1/4"W, 5.1/2"P
 *shown in MG



Morgan short
 ▶ #352003 - 4"H, 3.1/2"P
 ✚ #502003 - 5.1/2"H, 3.1/2"P
 ◆ #582003 - 5.1/2"H, 3.1/2"P

Morgan medium
 ✚ #502004 - 5.1/2"H, 4"P
 ◆ #582004 - 5.1/2"H, 4"P

*shown in AG-R



Morgan center
 ✚ #50203C - 3.1/2"H, 3.1/2"P
 ✚ #50204C - 3.1/2"H, 4"P
 ◆ #58203C - 3.1/2"H, 3.1/2"P
 ◆ #58204C - 3.1/2"H, 4"P
 *shown in AG-B



Morgan long
 ▶ #352006 - 4"H, 6"P
 ✚ #502006 - 5"H, 6.1/2"P
 ◆ #582006 - 5"H, 6.1/2"P
 *shown in MG



Inside Mount
 ▶ #352000 - 2.3/8"W, 3/4"L
 ✚ #502000 - 2.3/8"W, 13/16"L
 ◆ #582000 - 3.1/8"W, 1"L
 shown in MG



End Cap
 ✚ #501100 - 2.1/2"W, 1"L
 ◆ #581100 - 2.7/8"W, 1.1/4"L
 *shown in MG



Wand
 #900200 - 39"L
 #900225 - 49"L
 #900250 - 59"L
 *shown in MG



Thin Ring
 ✚ #506200 - 2.3/4"ID, 3.1/2"OD
 ◆ #586200 - 2.3/4"ID, 3.1/2"OD
 *shown in WWG



Plain Ring
 ▶ #356100 - 1.3/4"ID, 2.7/8"OD
 ✚ #506100 - 2.3/8"ID, 3.3/4"OD
 ◆ #586100 - 2.3/4"ID, 4.1/4"OD
 *shown in AG-R



Cuffed Ring
 ▶ #356120 - 1.3/4"ID, 2.7/8"OD
 ✚ #506120 - 2.3/8"ID, 3.3/4"OD
 ◆ #586120 - 2.3/4"ID, 4.1/4"OD
 *shown in MG

- ▶ color/shape indicates compatibility with 1 3/8" diameter poles
- ✚ color/shape indicates compatibility with 2" diameter poles
- ◆ color/shape indicates compatibility with 2 1/4" diameter poles

Combinations are available for most finials since items are custom made to order. Areas of solid color lacking intricate detail may have their finish crackled for an additional charge. Available finishes are: antique gold/black base coat (AG-B), antique gold / rust base coat (AG-R), antique silver / black base coat (AS-B), antique silver / rust base coat (AS-R), antique white (AW), antique white / crackled (AW-C), antique black (BL), chestnut (CH), antique black / crackled (BL-C), mahogany (MG), olive (OL), olive / crackled (OL-C), walnut (WA), white wash gold (WWG)



Copyright by Traditions of Charlotte

TRADITIONAL

MEDITERRANEAN

COLLECTION

Experience the attractiveness and versatility of Vesta's MEDITERRANEAN Collection featuring three appealing finishes and an assortment of hand-crafted iron accessories suitable for most design schemes. All hardware items are in-stock and ready for quick shipping.

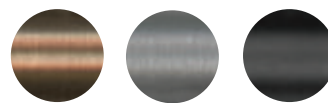

AB

EP

OB

AVAILABLE FINISHES:

- AB = antique brass
- EP = english pewter
- OB = old black

FINIALS

- A. Corsica
#201010 - 2.1/2"W, 6"L
*shown in EP
- B. Khios
#201210 - 3"W, 3.1/2"L
*shown in OB
- C. Cyprus
#201020 - 3"W, 3.1/2"L
*shown in OB
- D. Sicily
#201070 - 1.3/4"W, 1.3/4"L
*shown in AB
- E. End Cap (plain)
#201007 - 1"W, 1/2"L
*shown in EP
- F. Sitges
#201075 - 1.5/8"W, 1.3/4"L
*shown in EP
- G. Cadiz
#201005 - 1.1/4"W, 1/2"L
*shown in EP



AVAILABILITY:
in-stock, typically ships
within 24-48 hours

PRIMARY MATERIALS:
wrought iron, steel

DIAMETER & BRACKET
REQUIREMENTS:
3/4"D: bracket required
every 4-5 feet

BRACKETS



Bari short
#202030
2.7/8"H, 1.7/8"P
*shown in OB



Bari medium
#202040
2.7/8"H, 3.5/8"P-5"P
*shown in OB



Bari (open)
#202045
2.7/8"H, 3.5/8"P-5"P
*shown in OB



Elba
#202010
2.7/8"H, 3.1/4"L, 4.3/4"P
*shown in OB



Inside Mount (plain)
#202002 - 1"W, 1"L
*shown in AB

ACCESSORIES



Ring w/clip & insert
#206010 - 1.1/8"ID, 1.1/2"OD
*shown in OB



Brass Clip
#909111 - black



Ring w/eye
#206011 - 1.3/8"ID, 1.3/4"OD
*shown in AB



Rod Splice
#208090 - 4"L

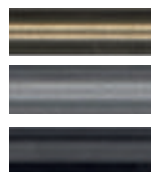

AB
EP
OB

Steel Tubing
#207150 - 3/4"D, 59"L
#207200 - 3/4"D, 78"L
#207250 - 3/4"D, 98"L
*sold as shown but will cut to your specified lengths
at no charge - longer lengths may be produced by
using this collection's rod splice



Wand
#911100 - 39"L
#911125 - 49"L
*shown in OB

SHIPPING & ADDITIONAL NOTES:

Due to changes in the shipping industry, rods at 96" are billed at the 90lb ground rate. The collection's rod splice can be used to achieve longer spans.



Copyright by Sarah Ponden Interiors / Abby Cole Photography

TRADITIONAL

OPERA

COLLECTION

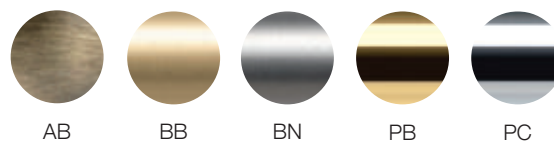

Vesta's OPERA Collection embodies a chorus of traditional and contemporary design philosophies suitable for many decorative design scenarios. Five radiant finishes enhance the performance of this group, and as an encore, all items are in-stock for quick shipping.

AVAILABLE FINISHES:

- AB = antique brass
- BB = brushed brass
- BN = brushed nickel
- PB = polished brass
- PC = polished chrome

FINIALS

- | | | |
|--------------------------------------------------------------------------------------------------------------------------------|--------------------------------------------------------------------------------------------------------------------------------------|---------------------------------------------------------------------------------------------------------------------------------|
| <p>A. Carmen (*shown in AB)
 ▲ #201603 - 1.1/2"W, 2.1/4"L
 ▼ #281603 - 2"W, 3"L</p> | <p>C. Bohemia (*shown in PB)
 ▲ #201602 - 1.1/4"W, 1.1/4"L
 ▼ #281602 - 1.3/4"W, 1.1/2"L</p> | <p>E. Handel (*shown in BB)
 ▲ #201616 - 1"W, 1.7/8"L
 ▼ #281616 - 1.3/8"W, 2.1/4"L</p> |
| <p>B. End Cap (*shown in BN)
 ▲ #201001 - 7/8"W, 3/4"L
 ▼ #281001 - 1.1/4"W, 3/4"L</p> | <p>D. Fidelio (*shown in PC)
 ▲ #201606 - 1.1/2"W, 2.1/8"L
 ▼ #281606 - 1.7/8"W, 2.7/8"L</p> | |

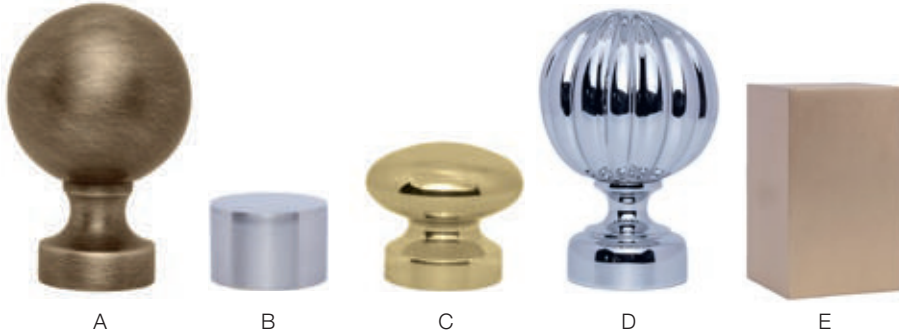

AVAILABILITY:
 in-stock, typically ships
 within 24-48 hours

PRIMARY MATERIALS:
 ■ brass

DIAMETER & BRACKET
 REQUIREMENTS:

- ▲ 3/4"D: bracket required every 4-5 feet
- ▼ 1 1/8"D: bracket required every 5-7 feet

BRACKETS



- Verdi
 ▲ #202106 - 1.5/8"W, 2.1/4"P
 ▲ #202115 - 1.5/8"W, 5.7/8"P
 ▼ #282106 - 2.3/8"W, 2.3/8"P
 ▼ #282115 - 2.3/8"W, 6"P

* stem may be cut for shorter projections ** may be used as ceiling bracket



- Wagner
 ▲ #202208 - 2"W, 2.7/8"P
 ▲ #202212 - 2"W, 4.1/2"P



- Wagner
 ▼ #282208 - 2"W, 3.1/8"P
 ▼ #282212 - 2"W, 4.3/4"P



- Wagner Double
 ▼ #282216
 2.1/4"W, 3.3/4" & 7.1/4"P



- Classico inside mount
 ▲ #202220 - 1"W, 7/8"L
 ▼ #282220 - 1.1/4"W, 1.1/16"L



- Inside Mount
 ▲ #202001 - 1.1/4"W, 1"L
 ▼ #282001 - 1.5/8"W, 1"L



- Incurve elbow w/return eyelets
 #289080 - 1.7/8"W, 3.1/8"P
 #289120 - 1.7/8"W, 4.3/4"P



Wand #910100 - 39"L #910125 - 49"L #910150 - 59"L

ACCESSORIES



- Tube Splice
 ▲ #208090 - 3/4"D, 6"L
 ▼ #298181 - 1.1/8"D, 6"L



- Tube Connector
 ▲ #209229
 ▼ #289229
 *adjusts 90° to 180°



- Flat Ring w/eye & insert
 ▲ #206061 - 1.1/8"ID, 1.1/2"OD
 ▼ #286061 - 1.5/8"ID, 2"OD



- Ring w/eye & insert
 ▲ #206031 - 1.1/8"ID, 1.1/2"OD
 ▼ #286031 - 1.1/4"OD, 1.3/4"OD



- Plastic Clip
 ▲ #909100 - 1/2"P
 ▼ #909101 - 5/8"P



- Brass Clip
 #909110



- Hollow Ring w/ clip
 ▲ #206030 - 1.1/4"ID, 1.11/16"OD
 ▼ #286030 - 1.7/16"ID, 2.1/8"OD



- Acrylic Wand
 #968100 - 39"L

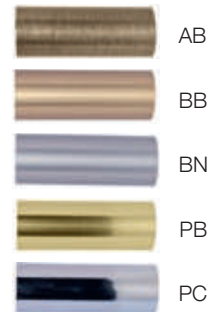

Brass Tubing
 ▲ #208000 - 3/4"D
 ▼ #288000 - 1.1/8"D
 *sold by the foot, will cut to your specified lengths, no charge



- Anne Loop
 #907630
 13"L, 5.1/2"P

SHIPPING & ADDITIONAL NOTES:

Splicing when applicable can significantly reduce freight charges. We can help you make the best informed decision when it's time to ship your order.



TRADITIONAL

ROYAL BRITANNICA

COLLECTION

Vesta's ROYAL BRITANNICA Collection features elements from the Old World and traditional disciplines of thought. All hardware is crafted by gifted artisans distinguishing it from the ordinary. Two stimulating finishes are in-stock for quick shipping.

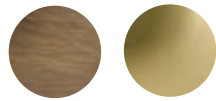

AB PB

AVAILABLE FINISHES:

- AB = antique brass
- PB = polished brass

FINIALS

- | | | |
|----------------------------------------------------------------------------------------------------------------------------|-----------------------------------------------------------------------------------------------------------------------------------|----------------------------------------------------------------|
| <p>A. Charlotte #401030
2.1/2"W, 2.1/4"L
*shown in AB</p> <p>B. Anne #401020
2.1/4"W, 2"L
*shown in PB</p> | <p>C. Elizabeth #401070
2.1/2"W, 3.1/2"L
*shown in AB</p> <p>D. Richard #401140
2.1/2"W, 4.1/2"L
*shown in PB</p> | <p>E. End Cap #401000
1.3/4"W, 7/8"L
* shown in PB</p> |
|----------------------------------------------------------------------------------------------------------------------------|-----------------------------------------------------------------------------------------------------------------------------------|----------------------------------------------------------------|











AVAILABILITY:
in-stock, typically ships
within 24-48 hours

PRIMARY MATERIALS:
■ brass

DIAMETER & BRACKET
REQUIREMENTS:
1 1/16"D: bracket required
every 6-8 feet

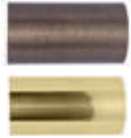

BRACKETS & ACCESSORIES

 <p>Charles wall bracket #402062 2.3/8"W, 2.5/8"P *shown in PB</p>	 <p>Ring w/eye #406011 2"ID, 2.3/8"OD *shown in PB</p>
 <p>#402066 2.3/8"W, 6.1/8"P *shown in PB</p>	 <p>Hollow Ring w/clip #406030 2"ID, 3"OD *shown in PB</p>
 <p>Inside Mount #402000 2.1/8"W, 1"L *shown in PB</p>	 <p>Brass Clip #909110 - brass #909111 - black</p>
 <p>Tube Splice #408090 6"L</p>	 <p>Anne Loop #907630 13"L, 5.1/2"P *shown in PB</p>
 <p>AB Plain Tubing #408000 1.9/16"D *sold by the foot, will cut to your specified lengths at no charge</p> <p>PB</p>	
 <p>Wand #910100 - 39"L #910125 - 49"L #910150 - 59"L</p>	

SHIPPING & ADDITIONAL NOTES:

Splicing when applicable can significantly reduce freight charges. We can help you make the best informed decision when it's time to ship your order.

MODERN

COLLECTION





Copyright by Sarah Catherine Select

MODERN

APOLLO

COLLECTION

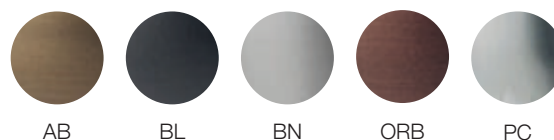

Vesta's APOLLO Collection features the bold strength of steel construction and five captivating finishes. Subtle elegance, various finial styles and an excellent price point make this collection an appealing solution for the discriminate designer.

AVAILABLE FINISHES:

- AB = antique brass
- BL = black
- BN = brushed nickel
- ORB = oil-rubbed bronze
- PC = polished chrome

FINIALS

- A. Harvest - #291501
2.3/8"W, 3.1/2"L
*shown in BL
- B. Tycho - #291601
2.1/8"W, 2.3/8"L
*shown in BN
- C. Helios - #291531
1.3/8"W, 1.1/4"L
*shown in PC
- D. Copernicus - #291581
2.1/4"W, 2.1/4"L
*shown in AB
- E. Orpheus - #291638
2.3/8"W, 3.1/2"L
*shown in ORB
- F. End Cap - #291500
1.3/8"W, 1/2"L
*shown in ORB



AVAILABILITY:
in-stock, typically ships
within 24-48 hours

PRIMARY MATERIALS:
■ steel/metal alloy

DIAMETER & BRACKET
REQUIREMENTS:
1 1/8"D: bracket required
every 5-7 feet

BRACKETS & ACCESSORIES



Diana short - #292740
2.1/2"W, 3"P
*shown in BN



Econo - #292791
1.1/2"H, 2.5/8"P
*shown in BL



Diana medium - #292741
2.1/2"W, 4"
*shown in ORB



Crescent - #292721
2"W, 8.1/4"P
*shown in BL

*stem can be cut to adjust the projection length



Diana double - #292742
2.1/2"W, 3" & 6.1/8"P
*shown in BN



Orbit long - #292795
1.15/16"W, 10.3/4"P
*shown in AB

*stem can be cut to adjust the projection length



Corvus Bracket - #292745
2.9/16"W, 4"P
*shown in AB



C Ring w/eye & insert
#296265 - 1.5/8"ID, 2"OD
*shown in BN

Flat Ring w/eye & insert
#296261 - 1.5/8"ID, 2"OD
*shown in AB



Corvus End Bracket
#292750
2.9/16"W, 4"P
*shown in BN



Holdback
#907751
*shown in BN
6.1/2"L, 4"P



Orbit Ceiling - #292760
1.15/16"W, 21/2"P
*shown in BN



Wand #900010 - 39" #900025 - 49" #900050 - 59"



Orbit - #292761
1.15/16"W, 3.3/8"P
*shown in AB



Tube Connector
#299229 - 1"W, 1"L
*shown in BN
**adjusts 90 to 180



LUNAR Elbow medium
#292120 - 2.9/16"W, 4"P
*shown in BL



Tube Splice
#298181
1.1/8"D, 4.3/4"L



LUNAR Elbow short
#292080 - 2.9/16"W, 3"P
*shown in BL



Inside Mount
#292701 - 1.5/8"W, 3/4"L
*shown in BN

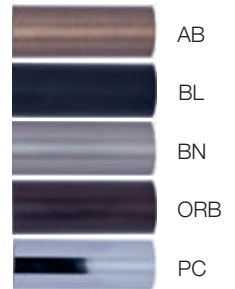

Steel Tubing
#298002
1.1/8"D

SHIPPING & ADDITIONAL NOTES:

Splicing when applicable can significantly reduce freight charges. We can help you make the best-informed decision when it's time to ship your order.



MODERN

CRYSTALENE

COLLECTION

Vesta's CRYSTALENE Collection features clean acrylic rods in (1.1/8" & 1.3/8") diameters accentuated with two classic finial designs and a traditional end cap. Finial bases, brackets and rings are offered in satin nickel and polished chrome and in-stock for quick shipping.



PC

SN

AVAILABLE FINISHES:

PC = polished chrome

SN = satin nickel

SAMPLE SETS



AVAILABILITY:
in-stock, typically ships
within 24-48 hours

PRIMARY MATERIALS:
■ acrylic

DIAMETER & BRACKET
REQUIREMENTS:

- ▲ 1½"D: bracket
required every 3-4 feet
- ▼ 1⅝"D: bracket
required every 4-5 feet

FINIALS



End Cap

- ▲ #281028 - 1.1/4"W, 1"L
- ▼ #351035 - 1.5/8"W, 1.1/8"L



Acrylic Ball

- ▲ #281828 - 2.5/8"W, 4"L
- ▼ #351835 - 2.7/8"W, 4.1/4"L



Acrylic Knob

- ▲ #281928 - 2.7/8"W, 3.1/8"L
- ▼ #351935 - 3.1/2", 3.1/4"L

BRACKETS & ACCESSORIES



Wall Bracket

- ▲ #282810 - 2" W, 3.3/4" P
*shown in PC



Wall Bracket

- ▼ #353510 - 2.9/16" W, 4.5/8" P
*shown in PC

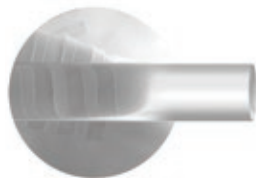

Acrylic Pole

- ▲ #281800 - 1.1.8"D, 71"L
- ▲ #282400 - 1.1.8"D, 94"L
- ▼ #351800 - 1.3/8"D, 71"L
- ▼ #352400 - 1.3/8"D, 94"L



Ring w/insert & clip

- ▲ #286028 - 1.3/8"ID, 1.5/8"OD
- ▼ #356035 - 1.13/16"ID, 2"OD
*shown in SN



Acrylic Wand
#968100 - 39"L



SHIPPING & ADDITIONAL NOTES:

Standard rod lengths (71" & 94") are within normal ground shipping rates.

MODERN



GEOLUX MANUAL

COLLECTION



Vesta's GEOLUX Collection features precisely machined, beautiful components from stainless steel and aluminum in popular finishes to provide a modern touch of elegance. A variety of bracket designs are available, creating a unique look and mounting flexibility.

AVAILABLE FINISHES:

- B = bronze
- G = gold
- S = silver
- BL = black
- SS = stainless steel

FINIALS & SAMPLE SETS

- A. End Cap (Flush)
▲ #201301 - 3/4"W, 3/16"L
*shown in black (BL)
- B. End Cap
▲ #201300 - 7/8", 5/8"L
*shown in stainless steel (SS)
- C. Sphere
▲ #201321 - 1.9/16"W, 2.1/2"L
*shown in gold (G)
- D. Cylinder notched
▲ #201313 - 7/8"W, 1.7/8"L
*shown in B
- E. Frustrum notched
▲ #201315 - 1.3/8"W, 3.1/8"L
*shown in BL
- F. Frustrum
▲ #201331 - 1.3/16"W, 1.3/8"L
*shown in SS

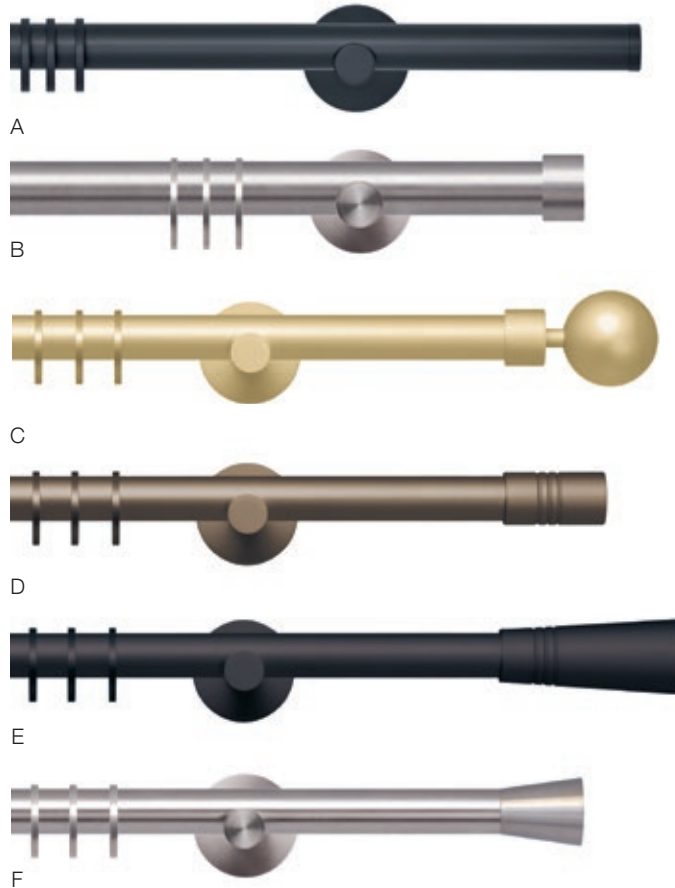

AVAILABILITY:
special order 3-4 weeks,
no returns

PRIMARY MATERIALS:
■ aluminum,
stainless steel

DIAMETER & BRACKET
REQUIREMENTS:

▲ 3/4"D: bracket required
every 3-5 feet

▼ 1 1/8"D: bracket required
every 4-6 feet

BRACKETS & ACCESSORIES



Lux wall bracket (short)
▲ #202406
*includes screw cover
1.7/8"W, 2.9/16"P



Lux wall bracket (medium)
▲ #202412
*includes screw cover
1.7/8"W, 4.3/4"P



Lux wall bracket (long)
▲ #202413
*includes screw cover
1.7/8"W, 6"P



Lux double wall bracket
▲ #202512
*includes screw cover
1.7/8"W, 2.9/16" & 4.3/4"P



Outdoor Mounting Plate
▲ #904001
*with screws suitable for
outdoor use



Inside Mount
▲ #202007
1"W, 7/8"L



Flat Ring w/clip
▲ #206257
1.1/8"D, 1.1/4"OD



Stainless Steel Tubing
▲ #218110 - 3/4"D
*sold by the foot but may be cut
to specified lengths, no charge



Tube Splice
▲ #208090 - 3/4"D, 4.3/4"L

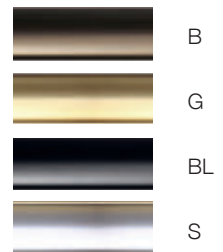

Aluminum Tubing
▲ #208060 - 3/4"D
*sold by the foot but may be cut
to specified lengths,
no charge

SHIPPING & ADDITIONAL NOTES:

Splicing when applicable can significantly reduce freight charges. We can help you make the best informed decision when it's time to ship your order. Aluminum components in B, G, S and BL are suitable for outdoor use with the purchase of the Outdoor Mounting Plate (#904001).

FINIALS & SAMPLE SETS

- A. End Cap (Flush)
 ▼ #281301 - 1.1/8"W, 7/16"L
 *shown in black (BL)
- B. End Cap
 ▼ #281300 - 1.1/4"W, 3/4"L
 *shown in stainless steel (SS)
- C. Cylinder (flush)
 ▼ #281331 - 1.1/8"W, 1.5/8"L
 *shown in black (BL)
- D. Globe
 ▼ #281325 - 1.7/8"W, 3"L
 *shown in bronze (B)
- E. Frustrum (flush)
 ▼ #281333 - 1.1/2"W, 1.7/8"L
 *shown in black (BL)

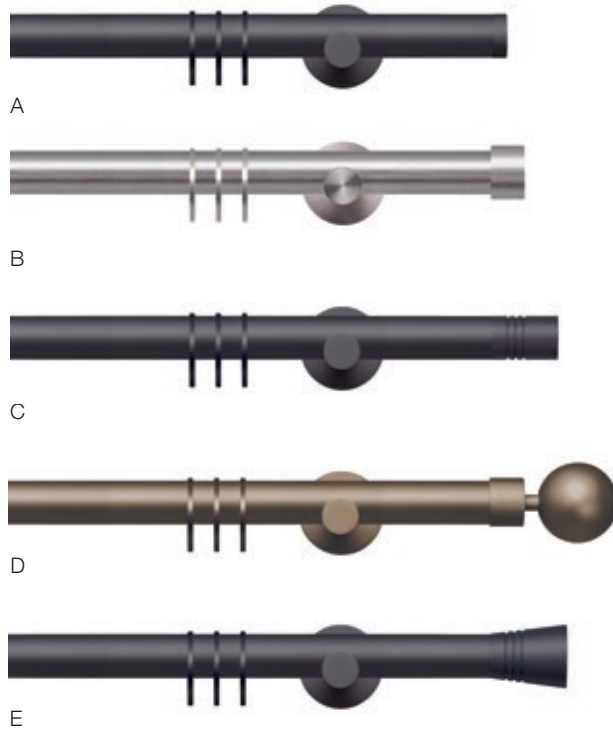
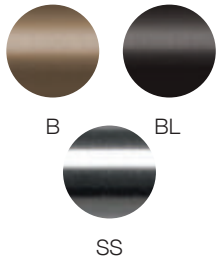

MODERN

BRACKETS & ACCESSORIES



Lux wall bracket (short)
 ▼ #282406
 *includes screw cover
 1.7/8" W, 3.1/8" P



Lux wall bracket (medium)
 ▼ #282440
 *includes screw cover
 1.7/8"W, 5.1/2" P



Lux double wall bracket
 ▼ #282512
 *includes screw cover
 1.7/8"W, 3.1/8"-5.1/2"P



Outdoor Mounting Plate
 ▼ #904001
 *with screws suitable for outdoor use



Inside Mount
 ▼ #282007
 1.1/4"W, 1.1/16"L



Flat Ring w/clip
 ▼ #286257
 1.3/4"ID, 1.7/8"OD



Stainless Steel Tubing
 ▼ #288110 - 1.1/8"D
 *sold by the foot but may be cut to specified lengths, no charge



Tube Splice
 ▼ #288090 - 1.1/8"D, 6"L

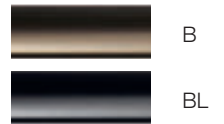

Aluminum Tubing
 ▼ #288060 - 1.1/8"D
 *sold by the foot but may be cut to specified lengths, no charge

WANDS



Wand
 #910100 - 39"L
 #910125 - 49"L
 #910150 - 59"L



Acrylic Wand
 #968100 - 39"L



MODERN



LE MANS MANUAL

COLLECTION

Vesta's LE MANS Collection features stylish and sleek finial designs for use on tubing. This is ideal for light to medium-weight treatments adding a touch of panache to any window décor.



BN

PC

PL

AVAILABLE FINISHES:

- BN = brushed nickel
- PC = polished chrome
- PL = palladium

FINIALS & SAMPLE SETS

A. End Cap (Flush)
#241241 - 1"W, 1/2"L
*shown in BN

B. End Cap
#241240 - 1.1/16"W, 3/4"L
*shown in PL

C. Bell
#243453 - 2.1/4"W, 3"L
*shown in BN

D. Ickx
#243520 - 1.1/2"W, 2.7/8"L
*shown in PL

E. Kristensen
#243447 - 1.5/8"W, 2.3/4"L
*shown in BN

F. Biela
#243521 - 1.3/8"W, 3.3/8"L
*shown in PC



A



C



E



B



D



F

AVAILABILITY:
special order 3-4 weeks,
no returns

PRIMARY MATERIALS:
■ aluminum

DIAMETER & BRACKET
REQUIREMENTS:
1"D: bracket required
every 4-5 feet

BRACKETS



Chenard wall bracket
#242408 - 1.7/8"W, 3.1/8"P *shown in PC



Chenard double wall bracket #242428 -
1.7/8"W, 3.1/8" & 5.1/2"P *shown in PC



Inside Mount
#242220 - 1.3/16"W, 1"L
*shown in PC

TUBING & ACCESSORIES



Rail/Tube Connector
#249229 - 1.7/8"L
*adjusts 90° to 180°



Tube Splice
#248090 - 3.3/4"L



Flat Ring w/insert & clip
#246257
1.5/8"ID, 1.7/8"OD



BN

PC

PL



Aluminum Tubing #248060 - 1"D
*sold by the foot but will cut to your specifica-
tions, no charge



Acrylic Wand #968100 -
39"L

SHIPPING & ADDITIONAL NOTES:

Splicing when applicable can significantly reduce freight charges. We can help you make the best informed decision when it's time to ship your order.



MODERN

Copyright Maggie Getz Studio / Aimee Mazzenga Photography

MISTRAL

COLLECTION



AB BB BN PB PC PN BL

Vesta's MISTRAL Collection features petite finial designs all produced to the highest standards. The hardware in this product grouping is ideally suited for contemporary light-weight café style window treatments. Seven popular finishes are available and in-stock for quick shipping.

AVAILABLE FINISHES:

- AB = antique brass
- BB = brushed brass
- BN = brushed nickel
- PB = polished brass
- PC = polished chrome
- PN = polished nickel
- BL = black

FINIALS

- A. End Cap
#101100 - 1/2"W, 3/8"L
*shown in PC
- B. Nice
#101110 - 5/8"W, 7/8"L
*shown in BL
- C. Monaco
#101120 - 3/4"W, 3/4"L
*shown in AB
- D. Cannes
#101130 - 5/8"W, 3/4"L
*shown in BB

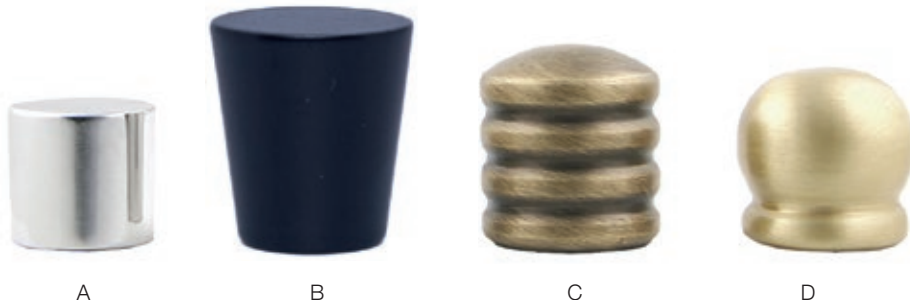

AVAILABILITY:
in-stock, typically ships
within 24-48 hours

PRIMARY MATERIALS:
■ brass

DIAMETER & BRACKET
REQUIREMENTS:
3/4"D: bracket required
every 36-42 inches

BRACKETS



Wall Bracket short
#102135 - 7/8"W, 1.3/8"P
*shown in PB



Wall Bracket medium
#102170 - 7/8"W, 2.3/4"P
*shown in BL



Sash Bracket
#102070 - 1/2"W, 5/8"P
*shown in BL



Inside Mount
#102100 - 5/8"W, 1/2"L
*shown in AB



Copyright Maggie Getz Studio / Aimee Mazzenga Photography

TUBING

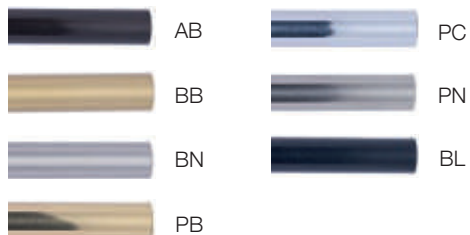

Brass Tubing
#108400 - 3/8"D

*sold by the foot (max 8') - may be cut to specified lengths, no charge

RINGS



Ring w/eye
#166031
15/16ID, 1.3/16"OD
*shown in AB



Flat Ring w/clip
#166061
11/16"ID, 1"OD
*shown in PB

SHIPPING & ADDITIONAL NOTES:

The maximum rod length in this collection is 96". If shipped at that length it will be billed at the 90lb. ground rate. Due to this collection's small diameter splicing is not recommended.

TRACK SYSTEMS

COLLECTION



Copyright Pure Design / Daniel Newcomb Photography



TRACK SYSTEMS



DECO [R]

COLLECTION



Vesta's popular Deco [R] collection features precision extruded rectangular aluminum tracks perfect for modern spaces. Five contemporary finishes are available.

AVAILABLE FINISHES:

- BL = black
- BN = brushed nickel
- PC = polished chrome
- PL = palladium
- BRG = brushed gold

FINIALS & SAMPLE SETS

- A. Fiona finial
#421080
1.9/16"H, 1.9/16"L
*shown in PL
- B. End Cap
#421015
9/16"W, 3/16"L
*shown in BRG

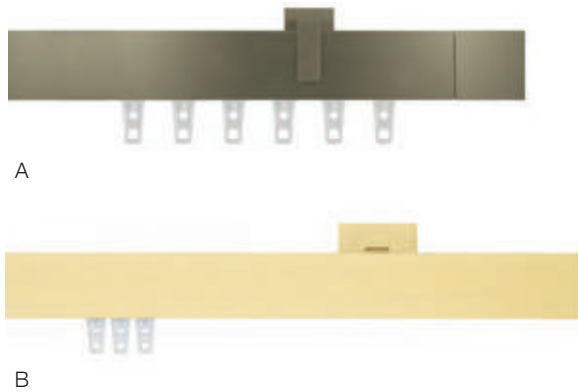



















AVAILABILITY:
most items in-stock,
typically ship within
24-48 hours.
(special order items take
3 - 4 weeks, no returns)

PRIMARY MATERIALS:
■ aluminum

**DIAMETER & BRACKET
REQUIREMENTS:**
1.9/16"H: bracket
required every 6-7 feet

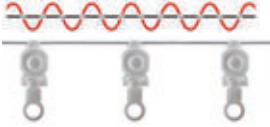
BRACKETS & ACCESSORIES

 <p>Deco [R] single bracket - #422750 1.9/16"W, 2.5/16"H, 3.1/8"P</p>	 <p>Bracket Extension #422540 (short) - 1.9/16"L #422580 (long) - 3.1/8"L *for bracket #422750</p>	 <p>Deco[R] ceiling/wall bracket #422753 - 2"W, 1.11/16"P #422755 - 2"W, 3.1/8"P</p>	 <p>Bracket Extension #422735 - 1.3/8"L *for bracket #422755</p>	 <p>Ext. Double Bracket #422772 1.9/16"W, 2.5/16"W, 3.5"-7.5"P</p>
 <p>Single Bracket #422751 2" W, 2" H, 3.1/8"P</p>	 <p>Ceiling Flush Mount #902592 3/4"W, 3/4"P (white, black, aluminum)</p>	 <p>Deco [R] Aluminum Track #428015 1.9/16"H, 9/16"W</p>	 <p>Track Connector #908993 2"L</p>	 <p>Swivel Track Connector #908994 1.3/4" x 1.3/4"L</p>
 <p>Roller Glide large #906520 - white #906521 - black 3/4"P</p>	 <p>Ceiling Bracket short #902474 5/8"W, 5/8"P</p>	 <p>Track Stop #908992 - white #908992B - black 3/8"P</p>	 <p>Roller Glide small #906575 - white 1/2"P</p>	 <p>Underlap Carrier [L] (white, grey, black) #918808 - with snap 1"W, 3.1/2"L (2.1/2" OC)</p>
 <p>Overlap Carrier [R] (white, grey, black) #918809 - with snap 1"W, 3.1/2"L (2.1/2" OC)</p>	 <p>Ball Bearing Roller Carrier #906706 - 60% fullness - 2.5/8"OC #906708 - 80% fullness - 2.3/8"OC #906710 - 100% fullness - 2.1/8"OC #906712 - 120% fullness - 1.7/8"OC * available in black or white *For 1" Snap Tape with 41/4" On-Center Spacing</p>			 <p>Acrylic Wand #968100 - 39"L</p>

SHIPPING & ADDITIONAL NOTES:

Splicing when applicable can significantly reduce freight charges. The created seam will be visible. We can help you make the best-informed decision when it's time to ship your order.

TRACK SYSTEMS



DECO TRAX

COLLECTION

Vesta's DECO TRAX Collection features a precision extruded aluminum oval track designed for long spans in contemporary settings. The bracket mounting points will not interfere with the movement of the gliders in any direction. Available in three contemporary finishes with most items available for quick shipping.

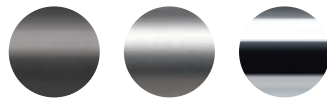

BL BN PC

AVAILABLE FINISHES:

- BL = black
- BN = brushed nickel
- PC = polished chrome

FINIALS & SAMPLE SETS

- A. End Cap(V)
▲ #431022
3/4"W, 3/16"L
*shown in BN
- B. Solara(V)
▲ #431080
1.9/16"W, 1.9/16"L
*shown in BL/PC

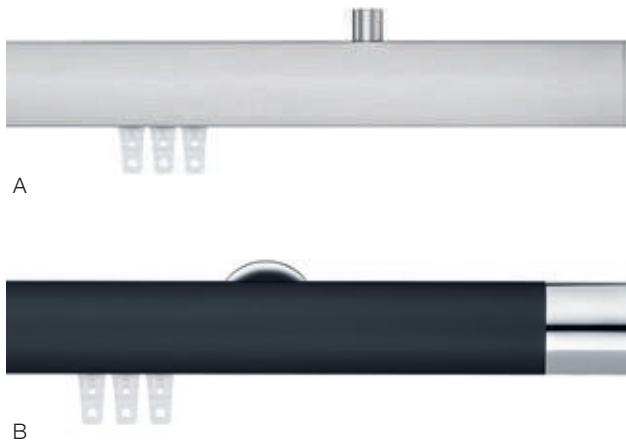

AVAILABILITY:
most items in-stock,
typically ship within
24-48 hours.
(special order items take
3 - 4 weeks, no returns)

PRIMARY MATERIALS:
■ aluminum











DIAMETER & BRACKET
REQUIREMENTS:

▲ 1 1/16"H: bracket required
every 6-7 feet

TRACK & BRACKETS

 <p>Deco (V) Aluminum Track - ▲ #438020 3/4"W, 1.9/16"H</p>	 <p>Deco(V) single bracket ▲ #432730 1.7/8"W, 3.1/8"P</p>	 <p>Ceiling Bracket short ▲ #902473 9/16"W, 5/8"P</p>	 <p>Deco(V) ceiling/wall bracket ▲ #902873 1.7/8", 1.11/16"P</p>	 <p>Ceiling Flush Mount(V) ▲ #902592 3/4"W, 3/4"P (white, black, aluminum)</p>	 <p>Double Bracket ▲ #432732 1.7/8"W, 3.1/8", 5.1/2"P</p>
----------------------------------------------------------------------------------------------------------------------------------------------------------	--------------------------------------------------------------------------------------------------------------------------------------------------------	----------------------------------------------------------------------------------------------------------------------------------------------------	---------------------------------------------------------------------------------------------------------------------------------------------------------------	-------------------------------------------------------------------------------------------------------------------------------------------------------------------------------	------------------------------------------------------------------------------------------------------------------------------------------------------

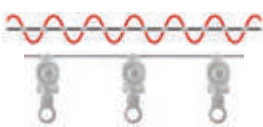
GLIDERS & ACCESSORIES

 <p>Butt Master Carrier #909909 - w/snap [L] #909910 - w/snap [R]</p>	 <p>Wheeled Butt Master #909906 - w/snap [L] #909907 - w/snap [R] *available in black or white</p>	 <p>Underlap Carrier [L] #909903 - w/o snap - 2.1/2"OC #909905 - with snap - 2.1/2"OC</p>  <p>Overlap Carrier [R] #909902 - w/o snap - 2.1/2"OC #909904 - with snap - 2.1/2"OC</p>	 <p>Track Connector #908993 - 2"L</p>	
 <p>Swivel Track Connector #908994 - 1.3/4"L x 1.3/4"L</p>	 <p>Roller Glide large #906520 - white - 3/4"P #906521 - black - 3/4"P</p>	 <p>Track Stop #908992 - white - 3/8"P #908992B - black - 3/8"P</p>	 <p>Roller Glide small #906575 - white 1/2"P</p>	 <p>Swivel Glide #906525 - grey 1/2"P</p>
 <p>Ball Bearing Roller Carrier #906706 - 60% fullness - 2.5/8"OC #906708 - 80% fullness - 2.3/8"OC #906710 - 100% fullness - 2.1/8"OC #906712 - 120% fullness - 1.7/8"OC available in black or white *For 1" Snap Tape with 41/4" On-Center Spacing</p>		 <p>Acrylic Wand #968100 - 39"L</p>		

SHIPPING & ADDITIONAL NOTES:

Splicing when applicable can significantly reduce freight charges. The created seam will be visible. We can help you make the best-informed decision when it's time to ship your order.

TRACK SYSTEMS



NOVI

COLLECTION



Vesta's NOVI Collection features precision extruded square aluminum tracks with meticulously machined bracket and finial designs. Several mounting possibilities make it a versatile collection suitable for any ultra-modern design scheme.

AVAILABLE FINISHES:

- BL = black
- BN = brushed nickel
- BRG = brushed gold
- PC = polished chrome
- WH = white

FINIALS & SAMPLE SETS

- A. Lohan
▲ #221010
3/4"W, 1.9/16"L
*shown in BN
*only available in BN & PC
- B. End Cap
▲ #221040
3/4"W, 3/16"L
*shown in BL
- C. End Cap
▼ #252510
1"W, 3/16"L
*shown in BRG











AVAILABILITY:
special order 3-4 weeks,
no returns

PRIMARY MATERIALS:
■ aluminum





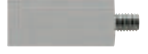









DIAMETER & BRACKET
REQUIREMENTS:

- ▲ 3/4"W: bracket required every 4-5 feet
- ▼ 1"W: bracket required every 5-6 feet

BRACKETS

 <p>Novi wall bracket ▲ #222080 - 2"W, 3.1/8"P ▼ #252580 - 2"W, 3.1/8"P</p>	 <p>Extension (short) ▲ #222740 - 1.9/16"L ▼ #252504 - 1.9/16"L</p>	 <p>Extension (medium) ▲ #222780 - 3.1/8"L ▼ #252508 - 3.1/8"L</p>	 <p>Novi extended double bracket ▼ #252525 2"W, 3.1/2" & 7.1/2"P</p>	 <p>Ceiling Flush Mount ▲▼ #902592 3/4"W, 3/4"P white, black, aluminum)</p>	 <p>Novi (short) ceiling bracket ▲▼ #902415 9/16"W, 9/16"P</p>
 <p>Extension ▲▼ #422735 - 1.3/8"L</p>	 <p>Novi (short) single wall/ceiling bracket ▲▼ #902273 - 2"W, 1.11/16"P</p>	 <p>Novi (long) single wall/ceiling bracket ▲▼ #902280 - 2"W, 3.1/8"P</p>			

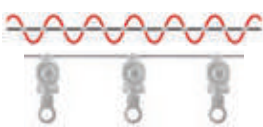
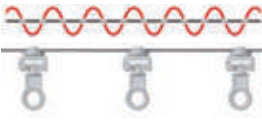
TRACK & ACCESSORIES

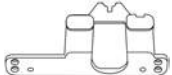
 <p>Novi Track ▲ #228020 - 3/4"W ▼ #252520 - 1"W *sold by the foot but will cut to your specifications, no charge</p>	 <p>Wheeled Butt Master #909906 - w/snap [L] #909907 - w/snap [R] *available in black, brown or white</p>	 <p>Underlap Carrier [L] ▼ #909903 - w/o snap - 2.1/2"OC ▼ #909905 - with snap - 2.1/2"OC</p>	 <p>Overlap Carrier [R] ▼ #909902 - w/o snap - 2.1/2"OC ▼ #909904 - with snap - 2.1/2"OC</p>	 <p>Track Connector ▲▼ #908993 - 2"L</p>	 <p>Acrylic Wand #968100 - 39"L</p>
 <p>Swivel Track Connector ▲▼ #908994 1.3/4"L x 1.3/4"L</p>	 <p>Roller Glide large ▼ #906520 - white 3/4"P ▼ #906521 - black 3/4"P</p>	 <p>Track Stop ▲▼ #908992 - white - 3/8"P ▲▼ #908992B - black - 3/8"P</p>	 <p>Roller Glide small ▲▼ #906575 white - 1/2"P</p>	 <p>Swivel Glider ▼ #906525 grey - 1/2"P</p>	 <p>Glider Hook short ▲▼ #906840 grey - 3/8"P</p>
 <p>Ball Bearing Roller Carrier ▼ #906706 - 60% fullness - 2.5/8"OC ▼ #906708 - 80% fullness - 2.3/8"OC ▼ #906710 - 100% fullness - 2.1/8"OC ▼ #906712 - 120% fullness - 1.7/8"OC available in black or white *For 1" Snap Tape with 4 1/4" On-Center Spacing</p>	 <p>Connected Snap Carrier ▲▼ #907006 - 60% fullness - 2.5/8"OC ▲▼ #907008 - 80% fullness - 2.3/8"OC ▲▼ #907010 - 100% fullness - 2.1/8"OC ▲▼ #907012 - 120% fullness - 1.7/8"OC *For 1" Snap Tape with 4 1/4" On-Center Spacing</p>	 <p>Underlap Carrier [L] (white, grey, black) ▲ #918808 - with snap 1"W, 3.1/2"L(2.1/2"OC)</p>	 <p>Overlap Carrier [R] (white, grey, black) ▲ #918809 - with snap 1"W, 3.1/2"L(2.1/2"OC)</p>		

SHIPPING & ADDITIONAL NOTES:

Splicing when applicable can significantly reduce freight charges. The created seam will be visible. We can help you make the best-informed decision when it's time to ship your order.

TRACK SYSTEMS



Copyright Parkcity Blind and Design / Josh Caldwell Photography

ECO-DECO

COLLECTION

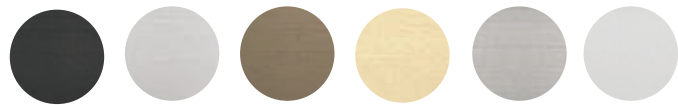

BBL BRA BRB BRG BRN WH

Vesta's ECO-DECO Collection is another exclusive Vesta offering featuring a simple extruded track available in five brushed finishes and powder coated white. A simple approach for small and large projects with an emphasis on rich finishes and a great price point.

AVAILABLE FINISHES:

- BBL = brushed black (anodized)
- BRA = brushed aluminum (anodized)
- BRB = brushed bronze (anodized)
- BRG = brushed gold (anodized)
- BRN = brushed nickel (anodized)
- WH = white (powder coated)

SAMPLE SETS



Brushed Black (BBL)



Brushed Gold (BRG)



Brushed Aluminum (BRA)



Brushed Nickel (BRN)



Brushed Bronze (BRB)



















White (WH)

AVAILABILITY:
special order 3-4 weeks,
no returns

PRIMARY MATERIALS:
■ aluminum

DIAMETER & BRACKET
REQUIREMENTS:
¾"W: bracket required
every 4-5 feet
1"W: bracket required
every 5-6 feet

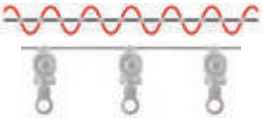
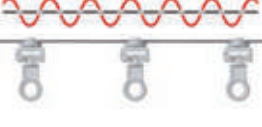
BRACKETS & ACCESSORIES

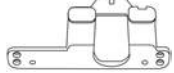
 Track #195185 - 3/4"W	 End Cap #191916 - 3/4" x 3/4"	 Click Ceiling Bracket #191618 1.5/8"L, 7/8"W	 Ceiling Mount #191616 9/16"W, 1.1/2"L	 Rail Connector #198993 1"W, 1.1/2"L
 Double Click Wall Bracket #191680 3/4"W, 1.3/4"P-5.1/2"P	 Click Wall Bracket #191670 3/4"W, 2.1/2"P	 Wall Bracket long #191660 5/8"W, 2"P	 Underlap Carrier [L] #909903 - w/o snap - 2.1/2"OC #909905 - with snap - 2.1/2"OC  Overlap Carrier [R] #909902 - w/o snap - 2.1/2"OC #909904 - with snap - 2.1/2"OC	
 Wheeled Butt Master #909906 - w/snap [L] #909907 - w/snap [R] *available in black or white	 Roller Glide large #906520 - white 3/4"P #906521 - black 3/4"P	 Roller Glide small #906575 white - 1/2"P	 Swivel Glider #906525 grey - 1/2"P	 Track Stop #908992 - white - 3/8"P #908992B - black - 3/8"P
 Ball Bearing Roller Carrier #906706 - 60% fullness - 2.5/8"OC #906708 - 80% fullness - 2.3/8"OC #906710 - 100% fullness - 2.1/8"OC #906712 - 120% fullness - 1.7/8"OC available in black or white *For 1" Snap Tape with 4/4" On-Center Spacing		 Connected Snap Carrier #907006 - 60% fullness - 2.5/8"OC #907008 - 80% fullness - 2.3/8"OC #907010 - 100% fullness - 2.1/8"OC #907012 - 120% fullness - 1.7/8"OC *For 1" Snap Tape with 4/4" On-Center Spacing		
 Underlap Carrier [L] (white, grey, black) #918808 - with snap "W, 3.1/2"L(2.1/2"OC)		 Overlap Carrier [R] (white, grey, black) #918809 - with snap 1"W, 3.1/2"L(2.1/2"OC)		

SHIPPING & ADDITIONAL NOTES:

Splicing when applicable can significantly reduce freight charges. The created seam will be visible. We can help you make the best-informed decision when it's time to ship your order.

TRACK SYSTEMS



GEOLUX TRACK

COLLECTION



Vesta's GEOLUX Collection features precisely machined, beautiful components from stainless steel and aluminum in popular finishes to provide a modern touch of elegance. A variety of bracket designs are available, creating a unique look and mounting flexibility.

AVAILABLE FINISHES:

- B = bronze
- G = gold
- S = silver
- BL = black
- SS = stainless steel

FINIALS & SAMPLE SETS

- A. End Cap (flush)
▲ #201301 - 3/4"W, 3/16"L
*shown in black (BL)
- B. End Cap
▲ #201300 - 7/8", 5/8"L
*shown in stainless steel (SS)
- C. Sphere
▲ #201321 - 1.9/16"W, 2.1/2"L
*shown in gold (G)
- D. Cylinder notched
▲ #201313 - 7/8"W, 1.7/8"L
*shown in B
- E. Frustrum notched
▲ #201315 - 1.3/8"W, 3.1/8"L
*shown in BL
- F. Frustrum
▲ #201331 - 1.3/16"W, 1.3/8"L
*shown in SS

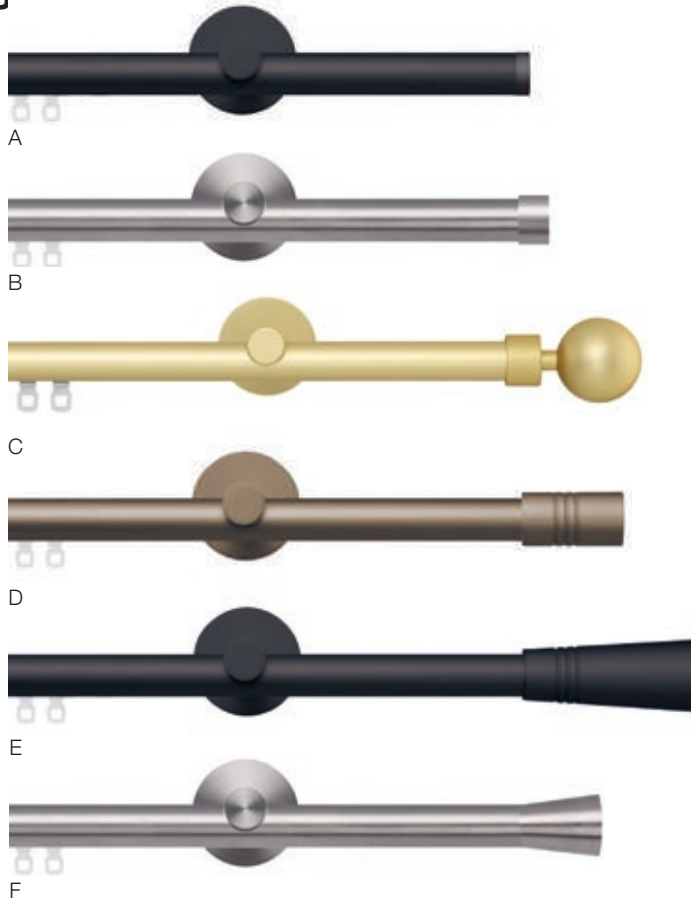

AVAILABILITY:
special order 3-4 weeks,
no returns

PRIMARY MATERIALS:

■ aluminum,
stainless steel

DIAMETER & BRACKET REQUIREMENTS:

- ▲ 3/4"D: bracket required every 3-5 feet
- ▼ 1 1/8"D: bracket required every 4-6 feet

BRACKETS & ACCESSORIES



Outdoor Mounting Plate
▲ #904001
*with screws suitable for outdoor use

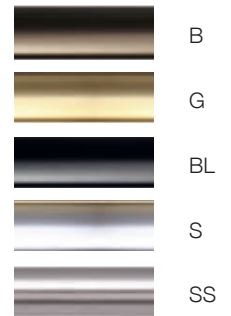

Lux wall bracket (short)
▲ #202406
1.7/8"W, 2.9/16"P



Inside Mount
▲ #202007
1"W, 7/8"L



Lux wall bracket (medium)
▲ #202412
1.7/8"W, 4.3/4"P



Lux wall bracket (long)
▲ #202413
1.7/8"W, 6"P



Lux double wall bracket
▲ #202512
1.7/8"W, 2.9/16"& 4.3/4"P

Connected Snap Carrier
▲ #907006 - 60% fullness - 2.5/8"OC
▲ #907008 - 80% fullness - 2.3/8"OC
▲ #907010 - 100% fullness - 2.1/8"OC
▲ #907012 - 120% fullness - 1.7/8"OC
*For 1" Snap Tape with 4/4" On-Center Spacing

GEO Techno Track
▲ #208080 - 3/4"D

SHIPPING & ADDITIONAL NOTES:

Splicing when applicable can significantly reduce freight charges. We can help you make the best informed decision when it's time to ship your order. Aluminum components in B, G, S and BL are suitable for outdoor use with the purchase of the Outdoor Mounting Plate (#904001).

FINIALS & SAMPLE SETS

- A. End Cap (Flush)
▼ #281301 - 1.1/8"W, 7/16"L
*shown in black (BL)
- B. End Cap
▼ #281300 - 1.1/4"W, 3/4"L
*shown in stainless steel (SS)
- C. Frustrum flush
▼ #281333 - 1.1/2"W, 1.7/8"L
*shown in black (BL)
- D. Globe
▼ #281325 - 1.7/8"W, 3"L
*shown in TWH
- E. Cylinder (flush)
▼ #281331 - 1.1/8"W, 1.5/8"L
*shown in black (B)

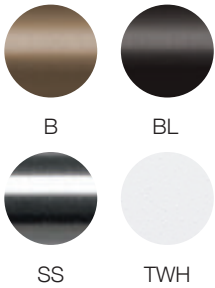

TWH= textured white
(only available in 1.1/8" track)

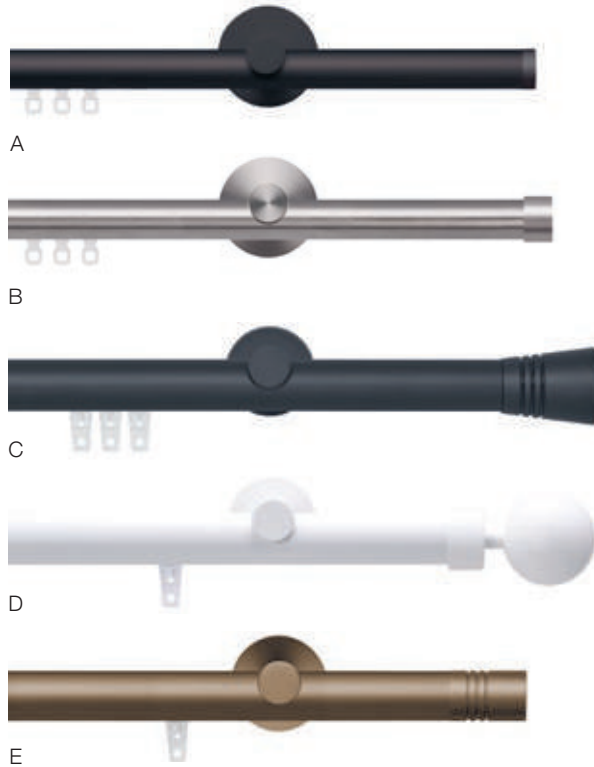

TRACK SYSTEMS



BRACKETS & ACCESSORIES



Lux wall bracket (short)
 ▼ #282406
 1.7/8" W, 3.1/8" P



Lux wall bracket (medium)
 ▼ #282440
 1.7/8"W, 5.1/2" P



Lux double wall bracket
 ▼ #282512
 1.7/8"W, 3.1/8"-5.1/2"P



Outdoor Mounting Plate
 ▼ #904001
 *with screws suitable for outdoor use



Inside Mount
 ▼ #282007
 1.1/4"W, 1.1/16"L

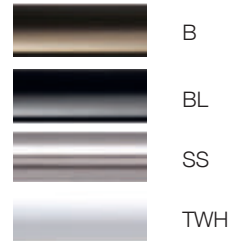

Aluminum Track
 ▼ #288080 - 1.1/8"D
 *sold by the foot but may be cut to specified lengths, no charge

CEILING BRACKETS & ACCESSORIES



Ceiling Bracket short
 ▲ ▼ #902491
 9/16"W, 5/8"L



Ceiling Bracket long
 ▲ ▼ #902493
 9/16"W, 1.3/8"L



Ceiling Bracket
 ▲ ▼ #902494
 1.7/8"W, 1.5/8"L



Ceiling Bracket
 ▲ ▼ #902595
 Black, White, Silver
 1.1/2"L, 7/16"W, 3/16"H



Ceiling Bracket
 ▲ ▼ #902597
 Black, White, Silver
 1.1/2"L, 7/8"W, 1/8"H



Track Connector
 ▲ ▼ #908993
 2"L



Glider Hook short
 ▲ ▼ #906840 - grey
 3/8"P



Roller Glide small
 ▲ ▼ #906575 - white
 1/2"P



Roller Glide large
 ▼ #906520 - white
 ▼ #906521 - black
 3/4"P



Swivel Glide
 ▼ #906525
 1/2"P



Track Stop
 ▲ ▼ #908992 - white
 ▲ ▼ #908992B - black
 3/8"P



Swivel Track Connector
 ▲ ▼ #908994
 1.3/4" x 1.3/4"L

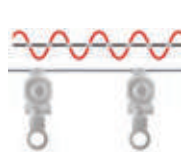

Ball Bearing Roller Carrier
 ▼ #906706 - 60% fullness
 ▼ #906708 - 80% fullness
 ▼ #906710 - 100% fullness
 ▼ #906712 - 120% fullness

*available in black or white

*For 1" Snap Tape with 4/4" On-Center Spacing



Underlap Carrier [L]
 ▼ #909905 - with snap
 ▼ #909903 - without snap



Overlap Carrier [R]
 ▼ #909904 - with snap
 ▼ #909902 - without snap



Wheeled Butt Master
 ▼ #909906 - w/snap [L]
 ▼ #909907 - w/snap [R]

*available in black or white



Underlap Carrier [L]
 (white, grey, black)
 ▲ #918808 - with snap
 1"W, 3.1/2"L (2.1/2" OC)



Overlap Carrier [R]
 (white, grey, black)
 ▲ #918809 - with snap
 1"W, 3.1/2"L (2.1/2" OC)



Wand
 #910100 - 39"
 #910125 - 49"
 #910150 - 59"



Acrylic Wand
 #968100 - 39"

TRACK SYSTEMS



MADE IN GERMANY
PRECISION ENGINEERING

LE MANS TRACK

COLLECTION

Vesta's LE MANS Collection features stylish and sleek finial designs for use on tracks. This is ideal for light to medium-weight treatments adding a touch of panache to any window décor.



BN

PC

PL

AVAILABLE FINISHES:

- BN = brushed nickel
- PC = polished chrome
- PL = palladium

FINIALS & SAMPLE SETS

- | | | |
|------------------------------------------------------------|-------------------------------------------------------|-------------------------------------------------------------|
| A. End Cap (Flush)
#241241 - 1"W, 1/2"L
*shown in BN | C. Bell
#243453 - 2.1/4"W, 3"L
*shown in BN | E. Kristensen
#243447 - 1.5/8"W, 2.3/4"L
*shown in BN |
| B. End Cap
#241240 - 1.1/16"W, 3/4"L
*shown in PL | D. Ickx
#243520 - 1.1/2"W, 2.7/8"L
*shown in PL | F. Biela
#243521 - 1.3/8"W, 3.3/8"L
*shown in PC |

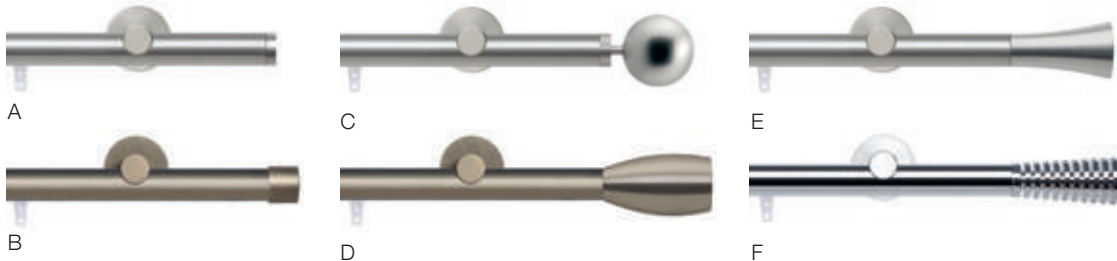

AVAILABILITY:
special order 3-4 weeks,
no returns

PRIMARY MATERIALS:
■ aluminum

DIAMETER & BRACKET
REQUIREMENTS:
1"D: bracket required
every 4-5 feet

BRACKETS

- | | |
|--|------------------------------------------------------------------------------------|
| | Le Mans wall bracket
#242708 - 1.7/8"W, 3.1/8"P
*shown in PC |
| | Le Mans double wall bracket
#242728 - 1.7/8"W, 3.1/8" &
5.1/2"P *shown in PC |
| | Ceiling Bracket (short)
#902473 - 9/16"W, 5/8"P *shown
in PC |
| | Ceiling Bracket
#902873 - 1.7/8"W, 1.11/16"P
*shown in PC |
| | Ceiling Bracket
#902595 Black, White, Silver
3/8"L, 1.9/16"W, 1/8"H |
| | Ceiling Bracket
#902597 Black, White, Silver
1.1/2"L, 7/8"W, 1/8"H |
| | Inside Mount
#242220 - 1.3/16"W, 1"L
*shown in PC |

TRACK & ACCESSORIES

- | | |
|--|------------------------------------------------------------------|
| | Rail/Tube Connector
#249229 - 1.7/8"L
*adjusts 90° to 180° |
| | Acrylic Wand
#968100 - 39"L |

GLIDER COMPONENTS

- | | | | | | |
|----------------------------------------------------------------------------------------------------------------------------------------------------------------------------|--------------------------------------|--|---------------------------------------|--|-------------------------------|
| | Glider Hook short
#906840 - 3/8"P | | Roller Glide small
#906575 - 1/2"P | | Track Stop
#908992 - 3/8"P |
| Underlap Carrier [L] (white, grey, black) #918808 - with snap
1"W, 3.1/2"L (2.1/2" OC) | | | | | |
| Overlap Carrier [R] (white, grey, black) #918809 - with snap
1"W, 3.1/2"L (2.1/2" OC) | | | | | |
| Connected Snap Carrier
#907006 - 60% fullness - 2.5/8"OC
#907008 - 80% fullness - 2.3/8"OC
#907010 - 100% fullness - 2.1/8"OC
#907012 - 120% fullness 1.7/8"OC | | | | | |

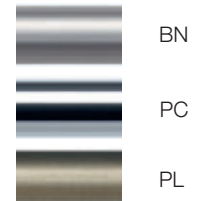

Aluminum Track
#248080 - 1"D
*sold by the foot but
will cut to your speci-
fications, no charge

*For 1" Snap Tape with 41/4" On-Center Spacing

SHIPPING & ADDITIONAL NOTES:

Splicing when applicable can significantly reduce freight charges. We can help you make the best informed decision when it's time to ship your order.



MADE IN GERMANY
PRECISION ENGINEERING

TRACK SYSTEMS

PURTEC MANUAL

COLLECTION



BL BN BRG PL PC

The PURTEC collection is a German Design Award Special 2022. Available in five stunning finishes, and offered in three configurations: manual, cord control, and motorized.

AVAILABLE FINISHES:

- BL = black
- BN = brushed nickel
- BRG = brushed gold
- PL = palladium
- PC = polished chrome

END CAPS & SAMPLE SETS

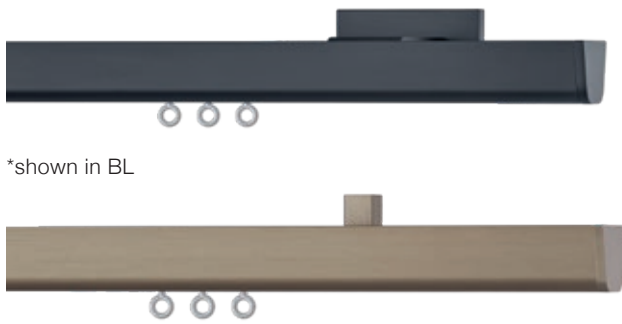

*shown in BL

*shown in PL



End Cap (Flush)
#321046 - 1.1/4" x 1.13/16"D

AVAILABILITY:
Special order, 3-4 weeks,
no returns

PRIMARY MATERIALS:
■ aluminum

DIAMETER & BRACKET
REQUIREMENTS:
1.1/4" X 1.13/16"D:
bracket required every
5-7 feet

BRACKETS & ACCESSORIES



Wall Bracket (Long) #322713
3.1/8"W, x 1.9/16"H, 5.1/8"P



Wall Bracket (Short) #322709
3.1/8"W, x 1.9/16"H, 3.1/2"P



PURTEC Rail #329191
1.1/4" x 1.13/16"D

CEILING MOUNT



Ceiling Bracket #902474
5/8"W, 5/8"P



Ceiling Mount #902475
2.3/4"L, 9/16"P



Ceiling Bracket (Short) #902273
2"W, 1.11/16"P



Ceiling Bracket (Long) #922280
2"W, 3.1/8"P



Extension #422735
1.3/8"L

ADDITIONAL HARDWARE



Butt Master Carrier
#909909 - w/snap [L]
#909910 - w/snap [R]



Wheeled Butt Master
#909906 - w/snap [L]
#909907 - w/snap [R]
*available in black, brown
or white



Underlap Carrier [L]
#909903 - w/o snap - 2.1/2"OC
#909905 - with snap - 2.1/2"OC



Track Connector
#908993 - 2"L



Overlap Carrier [R]
#909902 - w/o snap - 2.1/2"OC
#909904 - with snap - 2.1/2"OC



Track Connector
#908995 - 4.1/4"L



Swivel Track Connector
#908994 - 1.3/4"L x 1.3/4"L



Roller Glide large
#906520 - white 3/4"P
#906521 - black 3/4"P



Track Stop
#908992 - white - 3/8"P
#908992B - black - 3/8"P



Roller Glide small
#906575 - white - 1/2"P



Swivel Glide
#906525 - grey - 1/2"P

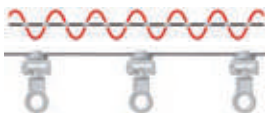

Connected Snap Carrier
#907006 - 60% fullness - 2.5/8"OC
#907008 - 80% fullness - 2.3/8"OC
#907010 - 100% fullness - 2.1/8"OC
#907012 - 120% fullness - 1.7/8"OC

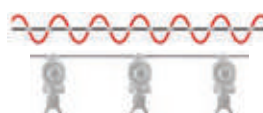

Ball Bearing Roller Carrier
#906706 - 60% fullness - 2.5/8"OC
#906708 - 80% fullness - 2.3/8"OC
#906710 - 100% fullness - 2.1/8"OC
#906712 - 120% fullness - 1.7/8"OC



Wand #966100 - 39" #966125 - 49" #966150 - 59"



Acrylic Wand #968100 - 39"L

SHIPPING & ADDITIONAL NOTES:

Splicing is not recommended for 1-Way systems.

TRACK SYSTEMS



Copyright by Sarah Ponden Interiors / Abby Cole Photography

TECHNO TRACK

COLLECTION

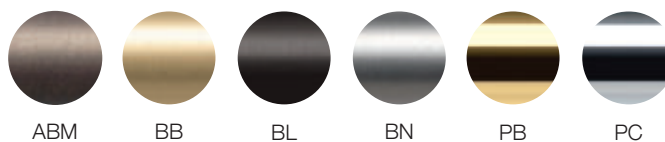





Vesta's TECHNO TRACK Collection is hand-traversing and designed with extensive one-way draws in mind. The collection's Techno brackets support the aluminum extruded track from above, allowing the gliders unfettered access along the entire bottom rail of track. Most items are stocked and available for quick shipping.

AVAILABLE FINISHES:

- ABM = antique brass matte
- BB = brushed brass
- BL = black
- BN = brushed nickel
- PB = polished brass
- PC = polished chrome

BRACKETS & TRACK ACCESSORIES

	Techno single bracket ▲ #202705 - 1.7/8"W, 2"P ▲ #202708 - 1.7/8"W, 3.1/8"P ▼ #282708 - 1.7/8"W, 3.1/8"P
	Techno single bracket long ▼ #282710 - 1.7/8"W, 4.3/4"P
	Techno double bracket ▲ #202728 - 1.7/8"W, 3.1/8" & 5.1/2"P ▼ #282728 - 1.7/8"W, 3.1/8" & 5.1/2"P
	Techno extended double bracket ▼ #282727 - 2.1/2"W, 3.1/8" & 6.5/8"P

ALUMINUM TRACK

*sold by the foot - will cut to your specifications, no charge



Standard Finish
▲ #208080 - 3/4"D (*BL, BN only)
▼ #288080 - 11/8"D (*BL, BN only)







Premium Finish
▲ #208083 - 3/4"D
▼ #288083 - 1.1/8"D
*ABM, BB, BN, PB, PC only

AVAILABILITY:
most items in-stock, typically ships within 24-48 hours. (special order finials from European Elegance and Geolux collections take 3 - 4 weeks, no returns)



















PRIMARY MATERIALS:
■ aluminum

DIAMETER & BRACKET REQUIREMENTS:

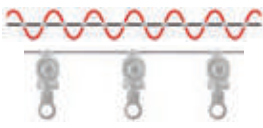
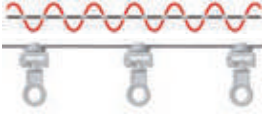
- ▲ 3/4"D: bracket required every 3-5 feet
- ▼ 1 1/8"D: bracket required every 5-7 feet

	Techno bracket extension ▲ #202744 - 1.9/16"L ▲ #202748 - 3.1/8"L ▼ #282744 - 1.9/16"L ▼ #282748 - 3.1/8"L		Ceiling bracket ▲▼ #902597 - 1.1/2"L, 7/8"W, 1/8"H	
			Ceiling bracket ▲▼ #902595 - 1.9/16"W, 1/8"H	
	Classico inside mount ▲ #202220 - 1"W, 7/8"L ▼ #282220 - 1.1/4"W, 1.1/16"L		Incurve elbow (w/return eyelets) ▼ #289080 - 1.7/8"W, 3.1/8"P ▼ #289120 - 1.7/8"W, 4.3/4"P <small>*the (ABM) & (BB) finishes on this item will vary slightly from the track</small>	Techno ceiling bracket ▲▼ #902873 1.7/8"W, 1.11/16"P

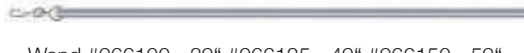
ADDITIONAL HARDWARE

	Butt Master Carrier ▼ #909909 - w/snap [L] ▼ #909910 - w/snap [R]		Wheeled Butt Master ▼ #909906 - w/snap [L] ▼ #909907 - w/snap [R] <small>*available in black or white</small>		Underlap Carrier [L] ▼ #909903 - w/o snap - 2.1/2"OC ▼ #909905 - with snap - 2.1/2"OC		Track Connector ▲▼ #908993 - 2"L								
	Overlap Carrier [R] ▼ #909902 - w/o snap - 2.1/2"OC ▼ #909904 - with snap - 2.1/2"OC		Rail/Tube Connector ▲ #209229 - 3/4"D ▼ #289229 - 1.1/8"D <small>*adjusts 90° to 180°</small>		Swivel Track Connector ▲▼ #908994 1.3/4"L x 1.3/4"L		Roller Glide large ▼ #906520 - white 3/4"P ▼ #906521 - black 3/4"P		Track Stop ▲▼ #908992 - white - 3/8"P ▲▼ #908992B - black - 3/8"P		Roller Glide small ▲▼ #906575 white - 1/2"P		Swivel Glider ▼ #906525 grey - 1/2"P		Glider Hook short ▲▼ #906840 grey - 3/8"P
	Ball Bearing Roller Carrier ▼ #906706 - 60% fullness - 2.5/8"OC ▼ #906708 - 80% fullness - 2.3/8"OC ▼ #906710 - 100% fullness - 2.1/8"OC ▼ #906712 - 120% fullness - 1.7/8"OC available in black or white <small>*For 1" Snap Tape with 1/4" On-Center Spacing</small>		Connected Snap Carrier ▲▼ #907006 - 60% fullness - 2.5/8"OC ▲▼ #907008 - 80% fullness - 2.3/8"OC ▲▼ #907010 - 100% fullness - 2.1/8"OC ▲▼ #907012 - 120% fullness - 1.7/8"OC <small>*For 1" Snap Tape with 1/4" On-Center Spacing</small>		Underlap Carrier [L] (white, grey, black) ▲ #918808 - with snap "W, 3.1/2"L(2.1/2"OC)		Overlap Carrier [R] (white, grey, black) ▲ #918809 - with snap 1"W, 3.1/2"L(2.1/2"OC)								
	End Cap ▲ #201240 ▼ #281240 7/8"W, 1/2"L, 1.1/4"W, 3/4"L		End Cap (Flush) ▲ #201241 ▼ #281241 3/4"W, 1/2"L, 1.1/8"W, 7/16"L		Wand #966100 - 39" #966125 - 49" #966150 - 59"		Acrylic Wand #968100 - 39"L	COMPATIBLE FINIALS FROM THE FOLLOWING COLLECTIONS ARE AVAILABLE: European Elegance (pg. 12-13), GeoLux (pgs. 55-56) & Opera (pg. 26-27) ask for more details							

SHIPPING & ADDITIONAL NOTES:

Splicing when applicable can significantly reduce freight charges. The created seam will be visible. We can help you make the best-informed decision when it's time to ship your order.

TRACK SYSTEMS



MADE IN GERMANY
PRECISION ENGINEERING

TITAN TRACK

COLLECTION

The TITAN TRACK Collection is a Vesta-inspired product line featuring precision fabricated finials, extruded aluminum track and three popular finishes. This hefty diameter provides a suitable alternative for heavier weight window treatment designs. All items are in-stock and available for quick shipping.



BL

BN

PC

AVAILABLE FINISHES:

BL = black

BN = brushed nickel

PC = polished chrome

FINIALS & SAMPLE SETS

- A. Hyperion (flush mount)
#351520
2.1/4"W, 4"L
*shown in PC
- B. Rhea (flush mount)
#351530
1.7/8"W, 3.5/16"L
*shown in BL
- C. Phoebe (flush mount)
#351570
2.1/2"W, 3.1/2"L
*shown in BL
- D. Cronus (flush mount)
#351525
1.3/4"W, 3.1/2"L
*shown in BL
- E. End Cap (flush mount)
#351500
1.3/8"W, 1/2"L
*shown in PC

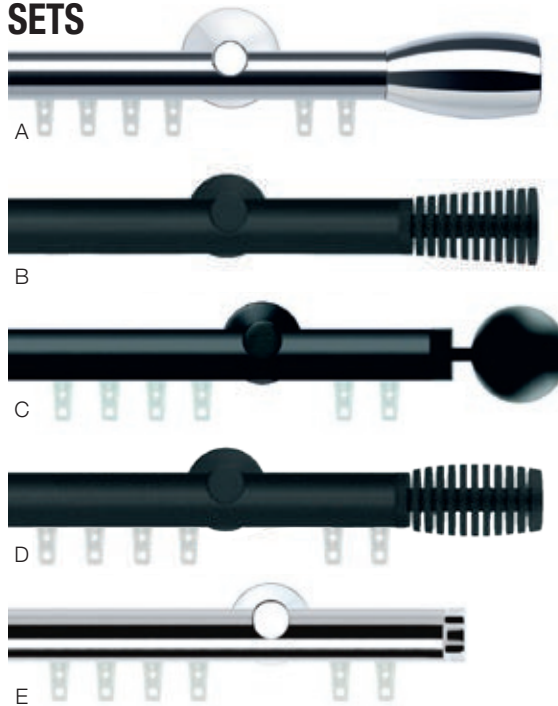















AVAILABILITY:
in-stock, typically ships
within 24-48 hours

PRIMARY MATERIALS:
■ aluminum

DIAMETER & BRACKET
REQUIREMENTS:
1 5/8"D: bracket required
every 6-8 feet

BRACKETS & ACCESSORIES

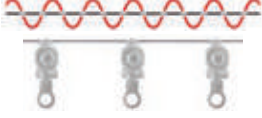
 <p>Ceiling bracket #902597 Black, White, Silver 1.1/2"L, 7/8"W, 1/8"H</p>	 <p>Wheeled Butt Master #909906 - w/snap [L] #909907 - w/snap [R] *available in black or white</p>	 <p>Underlap Carrier [L] #909903 - w/o snap - 2.1/2"OC #909905 - with snap - 2.1/2"OC</p>		 <p>Ceiling bracket #902873 1.7/8"W, 1.11/16"P</p>
 <p>Titan wall bracket #352770 2.9/16"W, 4"P</p>		 <p>Titan wall bracket #352780 2.9/16"W, 4"P</p>	 <p>Titan double bracket #352772 2.9/16"W, 4"P, 7.7/8"P</p>	 <p>Inside Mount #352220 1.9/16"W, 1.3/16"L</p>
 <p>Swivel Track Connector #908994 - 1.3/4"L x 1.3/4"L</p>	 <p>Track Connector #908993 - 2"L</p>	 <p>Roller Glide large #906520 - white - 3/4"P #906521 - black - 3/4"P</p>	 <p>Track Stop #908992 - white - 3/8"P #908992B - black - 3/8"P</p>	 <p>Swivel Glide #906525- grey - 1/2"P</p>
 <p>Acrylic Wand #968100 - 39"L</p>		 <p>Ball Bearing Roller Carrier #906706 - 60% fullness - 2.5/8"OC #906708 - 80% fullness - 2.3/8"OC #906710 - 100% fullness - 2.1/8"OC #906712 - 120% fullness - 1.7/8"OC</p>		

SHIPPING & ADDITIONAL NOTES:

Splicing when applicable can significantly reduce freight charges. The created seam will be visible. We can help you make the best-informed decision when it's time to ship your order.

CORD CONTROL

COLLECTION



CORD CONTROL



TECHNO TOPIA

COLLECTION

Vesta's TECHNO TOPIA Collection features a manual cord operated traverse system. Single and double treatments are possible with one-way or two-way draws. Numerous finial options are available to complete your decorative treatment. Most items are stocked and available for quick shipping.



BL

BN

PC

AVAILABLE FINISHES:

- BL = black
- BN = brushed nickel
- PC = polished chrome

FINIAL COMPATIBILITY CHART (sorted by finish)















Finish	Collection	Pages	Availability
BL	European Elegance	12-13	special order
	GeoLux	38	special order
BN	European Elegance	12-13	special order
	GeoLux (SS)	38	special order
	Opera	26-27	in-stock
PC	European Elegance	12-13	special order
	Opera	26-27	in-stock

AVAILABILITY:
 most items in-stock,
 typically ships within
 24-48 hours.
 (special order finials from
 European Elegance and
 Geolux collections take
 3 - 4 weeks, no returns)

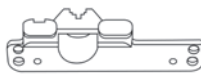
PRIMARY MATERIALS:
■ aluminum

**DIAMETER & BRACKET
 REQUIREMENTS:**
 1½”D: bracket required
 every 5-7 feet

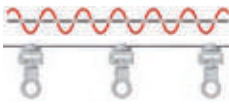
ALL HARDWARE

	Pulley Housing one-way draw #911686 - 1.1/8"W, 2.3/4"L *shown in PC		Classico inside mount #282220 - 1.1/4"W, 1.1/16"L *shown in BN
	Short Return Pulley #912484 - 1.1/8"W, 1.5/8"L *shown in PC		End Cap #281240 - 1.1/4"W, 3/4"L *shown in BL
	Pulley Housing two-way draw #911687 - 1.1/8"W, 2.3/4"L *shown in BL		Traverse Track with cord #289191 - 11/8"D *shown in BN
	Techno single bracket #282708 - 1.7/8"W, 3.1/8"P *shown in BL		Glider (white, grey, black) #912493 - 3/4"P
	Techno single bracket long #282710 - 1.7/8"W, 4.3/4"P *shown in BL		Underlap Carrier [L] (white, grey, black) #918808 - with snap 1"W, 3.1/2"L(2.1/2"OC)
	Techno extended double bracket #282727 - 2.1/2"W, 3.1/8" & 6.5/8"P *shown in BN		Overlap Carrier [R] (white, grey, black) #918809 - with snap 1"W, 3.1/2"L(2.1/2"OC)
	Ceiling Bracket #902873 - 1.7/8"W, 1.11/16"P *shown in PC		Connected Snap Carrier #907006 - 60% fullness - 2.5/8"OC #907008 - 80% fullness - 2.3/8"OC #907010 - 100% fullness - 2.1/8"OC #907012 - 120% fullness - 1.7/8"OC
	Track Connector #908995 - 4.1/4"L		

IMPORTANT NOTES

The hardware in this collection is assembled in our warehouse according to your provided specifications. Tampering with the inner workings of the traversing mechanisms will void our responsibility. No returns are permitted on this highly customized product.

Weight Load Recommendations		
3' - 6.5'	6.6' - 13'	13' - 19'
28 lbs.	26 lbs.	24 lbs.

WARNING

ANSI/WCMA100.1-2018 S2.2



Cord Tension Device
#997000 - 3"L

*if your window treatment includes a cord that creates a loop, you are required by law to install a tensioning device.

SHIPPING & ADDITIONAL NOTES:

Splicing is not recommended for 1-way draw systems.



CORD CONTROL



PURTEC CORD

COLLECTION



BL BN BRG PL PC

The PURTEC collection is a German Design Award Special 2022. Available in five stunning finishes, and offered in three configurations: manual, cord control, and motorized.

AVAILABLE FINISHES:

- BL = black
- BN = brushed nickel
- BRG = brushed gold
- PL = palladium
- PC = polished chrome

SAMPLE SET













*shown in BL

AVAILABILITY:
Special order, 3-4 weeks,
no returns

PRIMARY MATERIALS:
■ aluminum

DIAMETER & BRACKET
REQUIREMENTS:
1.1/4" X 1.13/16"D:
bracket required every
5-7 feet

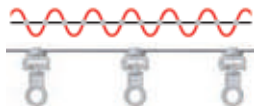



HARDWARE

 Cord Return Pulley w/Eye #329185 2.1/8"L, x 1.13/16"W	 Cord Return Pulley (1-Way Draw) #329186 2.1/8"L, x 1.13/16"W	 Pulley (Cord Side) #329187 2.1/8"L, x 1.13/16"W	 Underlap Carrier [L] (white, grey, black) #918808 - with snap 1"W, 3.1/2"L (2.1/2"OC)	 Overlap Carrier [R] (white, grey, black) #918809 - with snap 1"W, 3.1/2"L (2.1/2"OC)	 Butt Master Carrier #909909 - w/snap [L] #909910 - w/snap [R]
 Glider #912493 (black, grey, white) 3/4"P	 Cord Connector #912200 (black, grey, white)	 Cord #912250 (black, grey, white)	 Connected Snap Carrier #907006 - 60% fullness - 2.5/8"OC #907008 - 80% fullness - 2.3/8"OC #907010 - 100% fullness - 2.1/8"OC #907012 - 120% fullness 1.7/8"OC		<div style="border: 1px solid orange; padding: 5px;">WARNING <small>ANSI/WCMAA100.1-2018 S.2.2</small>  Cord Tension Device #997000 - 3"L *if your window treat- ment includes a cord that creates a loop, you are required by law to install a tensioning device.</div>
 Track Connector #908995 - 4.1/4"L					

BRACKETS & ACCESSORIES

 Wall Bracket (Long) #322713 3.1/8"W, x 1.9/16"H, 5.1/8"P
 Wall Bracket (Short) #322709 3.1/8"W, x 1.9/16"H, 3.1/2"P
 PURTEC Rail #329191 1.1/4" x 1.13/16"D
 f/Cord System #329292 11/16" x 11/16"

CEILING MOUNT

 Ceiling Bracket #902474 5/8"W, 5/8"P
 Ceiling Mount #902475 2.3/4"L, 9/16"P
 Ceiling Bracket (Short) #902273 2"W, 1.11/16"P
 Ceiling Bracket (Long) #922280 2"W, 3.1/8"P
 Extension #422735 1.3/8"L

IMPORTANT NOTES

The hardware in this collection is assembled in our warehouse according to your provided specifications. Tampering with the inner workings of the traversing mechanisms will void our responsibility. No returns are permitted on this highly customized product.

SHIPPING & ADDITIONAL NOTES:

Splicing is not recommended for 1-way draw systems.

DECO [R] CORD COLLECTION

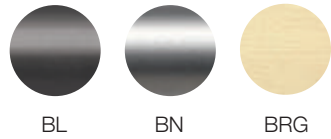

AVAILABLE FINISHES:

BL = black
 BN = brushed nickel
 BRG = brushed gold

AVAILABILITY:

most items in-stock, typically ship within 24-48 hours. (special order items take 3-4 weeks, no returns)

PRIMARY MATERIALS:

■ aluminum

DIAMETER & BRACKET REQUIREMENTS:

1.9/16" H: bracket required every 6-7 feet

CORDED CONTROL



*shown in BL
 Finials not compatible



Traverse Track with Cord
 Aluminum Track - #428715
 1.9/16"H, 9/16"W



Pulley Housing Cord Side
 #421152
 1.9/16"H, 1.9/16"L



Pulley Housing Return Side
 #421153
 1.9/16"H, 1.9/16"L

▲ WARNING
ANSI WCM A100.1-2018 5.2.2



Cord Tension Device
#997000 - 3"L

*if your window treatment includes a cord that creates a loop, you are required by law to install a tensioning device.

BRACKETS & ACCESSORIES



Deco [R]
 single bracket - #422750
 1.9/16"W, 2.5/16"H, 3.1/8"P



Bracket Extension
 #422540 (short) - 1.9/16"L
 #422580 (long) - 3.1/8"L
 *for bracket #422750



Deco [R] ceiling/wall bracket
 #422753 - 2"W, 1.11/16"P
 #422755 - 2"W, 3.1/8"P



Bracket Extension
 #422735 - 1.3/8"L
 *for bracket #422755



Ext. Double Bracket
 #422772
 1.9/16"W, 2.5/16"H, 3.5"-7.5"P



Single Bracket
 #422751
 2" W, 2" H, 3.1/8"P



Ceiling Flush Mount
 #902592
 3/4"W, 3/4"P (white, black, aluminum)



Track Connector
 #908993
 2"L



Ceiling Bracket short
 #902474
 5/8"W, 5/8"P



Glider
 (white, grey, black) -
 #912493
 3/4"



Underlap Carrier [L]
 (white, grey, black)
 #918808 - with snap
 1"W, 3.1/2"L (2.1/2" OC)



Overlap Carrier [R]
 (white, grey, black)
 #918809 - with snap
 1"W, 3.1/2"L (2.1/2" OC)

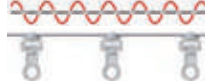

Connected Snap Carrier
 #907006 - 60% fullness - 2.5/8"OC
 #907008 - 80% fullness - 2.3/8"OC
 #907010 - 100% fullness - 2.1/8"OC
 #907012 - 120% fullness 1.7/8"OC

IMPORTANT NOTES

The hardware in this collection is assembled in our warehouse according to your provided specifications. Tampering with the inner workings of the traversing mechanisms will void our responsibility. No returns are permitted on this highly customized product.

SHIPPING & ADDITIONAL NOTES:

Splicing when applicable can significantly reduce freight charges. The created seam will be visible. We can help you make the best-informed decision when it's time to ship your order.

CORD CONTROL

HUNLEY CORD COLLECTION

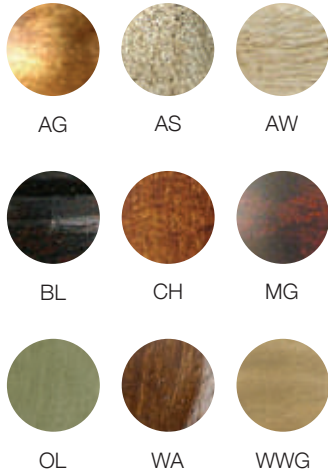

AVAILABLE FINISHES:

- AG-B = antique gold, black base coat
- AG-R = antique gold, rust base coat
- AS-R = antique silver, rust base coat
- AS-B = antique silver, black base coat
- AW = antique white
- AW-C = antique white / cracked
- BL = antique black
- BL-C = antique black / cracked
- CH = chestnut
- MG = mahogany
- OL = olive
- OL-C = olive / cracked
- WA = walnut
- WWG = white wash gold

AVAILABILITY:
special order 3-4 weeks, no returns

PRIMARY MATERIALS:
■ resin, wood

DIAMETER & BRACKET REQUIREMENTS:

- ▶ 1 3/8" D: bracket required every 4-5 feet
- ✦ 2" D: bracket required every 5-6 feet
- ◆ 2 1/4" D: bracket required every 6-8 feet

- 358100T Traverse Pole (plain)
- 358120T Traverse Pole (reeded)
- 358130T Traverse Pole (whittled)
- 358140T Traverse Pole (bamboo)
- 508100T Traverse Pole (plain)
- 508120T Traverse Pole (reeded)
- 508130T Traverse Pole (whittled)
- 508140T Traverse Pole (bamboo)
- 588100T Traverse Pole (plain)
- 588120T Traverse Pole (reeded)
- 588130T Traverse Pole (whittled)
- 588140T Traverse Pole (bamboo)

TRAVERSE SETS



▶ #358120T
*shown in AS-B



✦ #508140T
*shown in CH

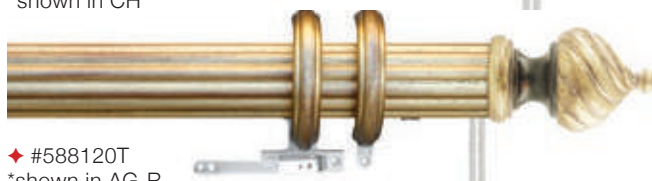

◆ #588120T
*shown in AG-R

OPTIONAL TRAVERSE ITEMS ADD-ONS



Single Bracket Heavy Duty
#582020 - 1.1/2"W, 3.1/2"-4.1/4"P
*white or brown



Multi Bracket Heavy Duty
#582025 - 1.1/2"W, 2.3/8"-6.1/4" (variable)
*white or brown



Traverse Ring
for 2 1/4"D only
#586120T (cuffed)

STANDARD ITEMS INCLUDED WITH SET ORDER

quantities of each item determined by your overall length



End Bracket
*white or brown
1.5/8"W, 2.3/4"-4.1/8"P



Center Bracket
*white or brown
*includes paintable cover
1"W, 2.3/4"-4.1/8"P



Ceiling Bracket
*designate these for
ceiling installations



*if your window treatment includes a cord that creates a loop, you are required by law to install a tensioning device.

Cord Tension Device

SHIPPING & ADDITIONAL NOTES:

Splicing when applicable can significantly reduce freight charges. We can help you make the best informed decision when it's time to ship your order.

MOTOR CONTROL

COLLECTION



MOTOR CONTROL



MOTOPIA

COLLECTION

Vesta's MOTOPIA Collection features precision extruded decorative aluminum tracks powered by a belt driven wire-free motor. The silent system operates with a 5-channel (RF) remote control, and can hold a charge for up to one year.

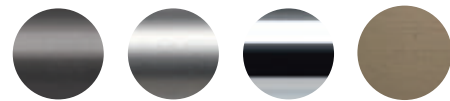

BL BN PC BRB

AVAILABLE FINISHES:









- BL = black
- BN = brushed nickel
- PC = polished chrome
- BRB = brushed bronze

BRACKETS & ACCESSORIES







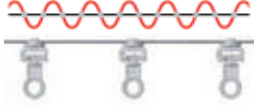

AVAILABILITY:
Special order, 3-4 weeks,
no returns

PRIMARY MATERIALS:
■ aluminum

DIAMETER & BRACKET
REQUIREMENTS:
1½”D: bracket required
every 5-7 feet

 <p>Wall Bracket #282710 1.7/8”W, 4.3/4”P</p>	 <p>Extended Double Bracket #282929 2.1/2”W, 4.5/16” & 8.5/8”</p>	 <p>Angle Support #289850 6.7/8”L, 8”P</p>	 <p>Glider #912493-GR - 3/4”P #912493-L - 3/4”P #912493 -WH - 3/4”P</p>	
 <p>Return Pulley Assembly #912483 3.1/8”W, 4.3/4”L *specify right or left side</p>	 <p>Return Pulley Short #912484 1.1/8”W, 1.5/8”L</p>  <p>Track Connector #908995 - 4.1/4”L</p>	 <p>Underlap master carrier #918808 1”W, 3.1/2”L (2.1/2”OC)</p>	 <p>Overlap master carrier #918809 1”W, 3.1/2”L (2.1/2”OC)</p>	 <p>Connected Snap Carrier #907006 - 60% fullness - 2.5/8”OC #907008 - 80% fullness - 2.3/8”OC #907010 - 100% fullness - 2.1/8”OC #907012 - 120% fullness 1.7/8”OC</p>

MOTOR HARDWARE SOMFY

 <p>Somfy Glydea Ultra 60e RTS #912660 12.15/16”L</p>	 <p>Wire-Free Motor #912690 - 12.1/8”H, 3.5/8”W *3-year limited manufacturer's warranty subject to terms and conditions - call for details</p>
 <p>Charging Unit #912696</p>	 <p>Remote #912695 (RF) 5-channel</p>
 <p>Motor Housing Assembly #912699 4.1/4”W, 4.3/4”L *specify right or left side</p>	 <p>Kevlar Belt #912400</p>
 <p>Traverse Track #289090 - 1.1/8” *sold by the foot</p>	 <p>Kevlar Belt Connector #912492</p>

MOTOR HARDWARE MOTIONBLINDS

 <p>Motionblinds Motor #911660 16.1/2”L</p>  	 <p>Eve Motionblinds Motor #911661 16.1/2”L</p>   		
 <p>Motor Pulley (left) #912700 2.7/8”W, 4.3/4”L</p>	 <p>Motor Pulley (right) #912700 2.7/8”W, 4.3/4”L</p>	 <p>Motor In-Line Pulley #912600 1.7/8”W, 1.7/8”L</p>	 <p>Remote Control #911665</p>  <p>Charging Cable #911666</p>

IMPORTANT

TAMPERING WITH THE MOTOR FOR ANY REASON IMMEDIATELY VOIDS THE MANUFACTURER WARRANTY. Vesta will not be held responsible for damage to your motor if your draperies touch and therefore drag across the floor (puddling) during operation. **No returns are permitted on this highly customized product.**

SHIPPING & ADDITIONAL NOTES:

Vesta will not be responsible for damage to your motor if your draperies touch, and therefore drag across the floor (puddling) during operation.



MOTOR CONTROL

MADE IN GERMANY
PRECISION ENGINEERING

PURTEC MOTOR

COLLECTION



BL BN BRG PL PC

The PURTEC collection is a German Design Award Special 2022. Available in five stunning finishes, and offered in three configurations: manual, cord control, and motorized.

AVAILABLE FINISHES:

- BL = black
- BN = brushed nickel
- BRG = brushed gold
- PL = palladium
- PC = polished chrome

MOTORIZED TRACKS



*shown in BL

AVAILABILITY:
Special order, 3-4 weeks,
no returns

PRIMARY MATERIALS:
■ aluminum

DIAMETER & BRACKET
REQUIREMENTS:
1.1/4" X 1.13/16"D:
bracket required every
5-7 feet

BRACKETS & ACCESSORIES

Wall Bracket (Long) #322713 3.1/8"W, x 1.9/16"H, 5.1/8"P	PURTEC Rail #329191 1.1/4" x 1.13/16"D	f/Motor System #329292 11/16" x 11/16"	Extension #422735 1.3/8"L	Ceiling Mount #902475 2.3/4"L, 9/16"P	Ceiling Bracket (Long) #922280 2"W, 3.1/8"P	Ceiling Bracket (Short) #902273 2"W, 1.11/16"P
Ceiling Bracket #902474 5/8"W, 5/8"P	Underlap Carrier [L] (white, grey, black) #918808 - with snap 1"W, 3.1/2"L (2.1/2"OC)	Overlap Carrier [R] (white, grey, black) #918809 - with snap	Butt Master Carrier #909909 - w/snap [L] #909910 - w/snap [R]	Connected Snap Carrier #907006 - 60% fullness - 2.5/8"OC #907008 - 80% fullness - 2.3/8"OC #907010 - 100% fullness - 2.1/8"OC #907012 - 120% fullness 1.7/8"OC	Glider #912493 (black, grey, white) 3/4"P	Track Connector #908995 4.1/4"L

MOTOR HARDWARE SOMFY

Somfy Glydea Ultra 60e RTS #912660 12.15/16"L	Somfy Irismo 45 RTS #912690 12.1/8"L	Remote #912695 (RF) 5-channel	Kevlar Belt #912400
Charging Unit #912696	In-Line Motor Housing #913246 3.5/16"L, 2.1/4"W	Kevlar Belt Connector #912492	
Motor Housing (left) #913299 4.1/2"L, 4.5/8"W	Return Pulley (right) #913283 4.1/2"L, 3.15/16"W	Return Pulley (short) #913284 2.1/8"L, 1.13/16"W	

MOTOR HARDWARE MOTIONBLINDS

Motionblinds Motor #911660 16.1/2"L	Eye Motionblinds Motor #911661 16.1/2"L			
Motor Pulley (left) #911216 3.1/4"W, 4.1/2"L	Motor Pulley (right) #911216 3.1/4"W, 4.1/2"L	Motor In-Line Pulley # 911217 1.7/8"W, 1.7/8"L	Remote Control #911665	Charging Cable #911666

SHIPPING & ADDITIONAL NOTES:

Splicing is not recommended for 1-way draw systems.

FAQ'S

FREQUENTLY ASKED QUESTIONS

Q: WHAT FORMS OF PAYMENT ARE ACCEPTED?

A: Vesta accepts American Express, Discover, MasterCard, Visa, Company Check and C.O.D.

Q: WHAT IS THE BEST WAY TO CLEAN BRASS?

A: Typically a dry dust cloth is all that is required. In some cases, a solution of warm water and mild soap can be used. **DO NOT USE ANY HARSH CHEMICALS OR ABRASIVES.** All brass is polished and lacquered. Gloves should be worn during installation to protect the surface finish.

Q: WHAT IS THE BEST WAY TO CLEAN ALUMINUM?

A: Typically a dry dust cloth is all that is required. In some cases, a solution of warm water and mild soap can be used. For stubborn areas like fingerprints a multi-purpose cleaner such as Ballistol® can be used to clean the surface area. **DO NOT USE ANY HARSH CHEMICALS OR ABRASIVES.** Gloves should be worn during installation to protect the surface finish.

Q: HOW IS SHIPPING HANDLED?

A: Vesta uses various shipping companies to deliver your order. Due to the nature of our product rods/tracks are sometimes packed separately from the hardware. As a result, the smaller packages are handled differently than the longer packages, and on occasion delivered at different times. This applies to ground shipped packages only. Premium air service is backed by a delivery guarantee for all packages tendered. If and when feasible we can pack everything in a large corrugated tube or Reddi-Crate® box. Vesta ships all orders complete on the same day unless instructed otherwise. **ALL SHIPMENTS SHOULD BE INSPECTED UPON RECEIPT.** For damages that are visibly blatant, we suggest that you refuse the shipment. At a minimum, notes must be made on the Bill of Lading for LTL shipments and reported to Vesta immediately. For concealed damage when no physical evidence is apparent, a report must be made within five business days to honor the claim.

Q: HOW ARE SHIPPING CHARGES CALCULATED?

A: The shipping trade has changed in recent years, and the effects have been felt throughout our industry. Terminology such as "over length" and "extreme length" are now used by carriers to classify packages within a certain DIM (L x W x H) range to rate shipments. Any package measuring 97"-108" will be rated at the 90 lb. ground rate. All LTL packages measuring 120"-143" are classified as "over length". Packages greater than 144" are classified as "extreme length" FedEx Freight has adopted 4 new categories of "extreme length" surcharges ranging from \$480 - \$1,015. All rates vary depending on geographical location. We check all carrier rates for the best possible rate.

COLLECTIONS GROUPED BY CATEGORY

TRADITIONAL	5-29	TRACK SYSTEMS	45-65
BLACKSMITH	6-7	DECO [R]	46-47
BRISE BISE	8-9	DECO TRAX	48-49
CASTILIAN	10-11	NOVI	50-51
EUROPEAN ELEGANCE	12-13	ECO-DECO	52-53
HELENA	14-15	GEOLUX TRACK	54-57
HIGHLAND TIMBER	16-19	LE MANS TRACK	58-59
HUNLEY	20-23	PURTEC MANUAL	60-61
MEDITERRANEAN	24-25	TECHNO TRACK	62-63
OPERA	26-27	TITAN TRACK	64-65
ROYAL BRITANNICA	28-29		
MODERN	31-43	CORD CONTROL	67-73
APOLLO	32-33	TECHNO TOPIA	68-69
CRYSTALENE	34-35	PURTEC CORD	70-71
GEOLUX MANUAL	36-39	DECO [R] CORD	72
LE MANS MANUAL	40-41	HUNLEY CORD	73
MISTRAL	42-43	MOTOR CONTROL	75-79
		MOTOPIA	76-77
		PURTEC MOTOR	78-79

Available Through:



ONA DRAPERY HARDWARE COMPANY

5320 ARAPAHOE AVE. BOULDER, CO 80303

1-800-231-4025 / FAX: 1-888-231-4026

(LOCAL 303-442-8755 / FAX: 303-786-7159)

www.onadrapery.com / email: info@onadrapery.com

SHIPPING TIME ESTIMATES

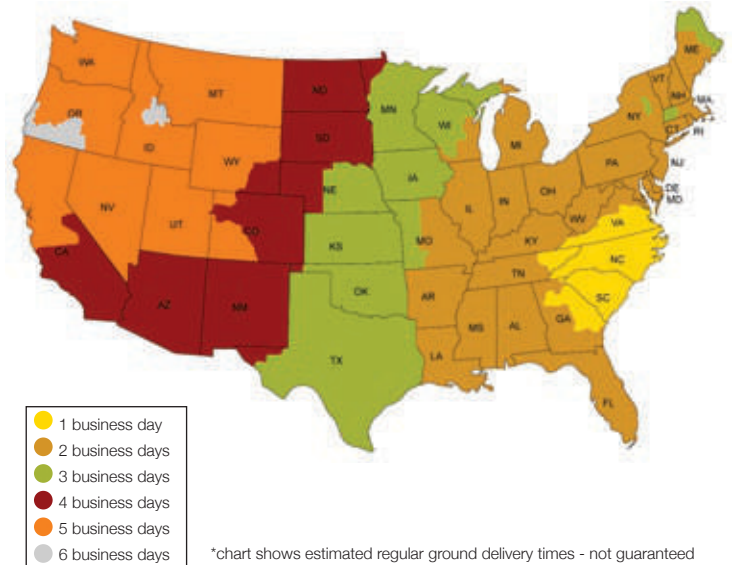

The chart below displays an estimated delivery time from our location in Pendleton, South Carolina via "regular ground" services. You may inquire about premium delivery options and estimated delivery charges at the time you place your order.

Vesta ships to locations in the domestic United States including Hawaii*, Alaska* and Puerto Rico* (please call for estimated freight to destinations marked with an asterisk).

©2024 Vesta Inc. All Rights Reserved.

All images and copy included in this printed catalog and in our online showroom are produced for our purposes. No images or text may be duplicated in any form without Vesta's expressed written consent. Colors and finishes should be close but customers should expect slight variations due to the processes involved in four-color printing and posting material online. Vesta is providing these materials in good faith and may not be held responsible for any typographic errors regarding our products, our pricing or product availability. Furthermore, Vesta is not responsible for any outages or discontinuance from our suppliers. The responsibility of determining an appropriate collection and diameter to properly support the weight of any proposed window treatment ultimately rests with the person placing the order or their installer. Vesta can only make generalized recommendations based on information provided by the customer.

All merchandise should be inspected immediately upon receipt to resolve any claims with all parties involved in the transaction. Special order items CAN NOT be returned. There may be a 25% restocking fee associated with any returned merchandise and in ALL instances, accepting any returned merchandise is subject to Vesta's inspection.